

# Operating instructions

## Washing machine



To avoid the risk of accidents or damage to the appliance, it is **essential** to read these instructions before it is installed and used for the first time.

# Contents

---

<b>Caring for the environment</b> .....	6
<b>Warning and Safety instructions</b> .....	7
<b>Operating the washing machine</b> .....	14
Control panel .....	14
Examples on how to operate the appliance .....	16
<b>Before using for the first time</b> .....	17
Setting the language .....	18
Messages .....	18
Running the first programme.....	18
<b>TwinDos</b> .....	19
Inserting detergent cartridges .....	20
Using containers .....	21
Opening the Settings menu.....	22
Settings for UltraPhase 1 and UltraPhase 2.....	22
Settings for other types of detergent .....	23
Running the first programme.....	24
<b>Washing environmentally and economically</b> .....	25
EcoFeedback.....	26
<b>1. Preparing the laundry</b> .....	27
<b>2. Selecting a programme</b> .....	28
<b>3. Loading the washing machine</b> .....	29
<b>4. Selecting programme settings</b> .....	30
<b>5. Adding detergent</b> .....	32
TwinDos.....	32
Detergent dispenser drawer .....	33
CapDosing.....	34
<b>6. Starting the programme - the end of the programme</b> .....	36
<b>Spinning</b> .....	37

<b>Delay start</b> .....	39
Selecting Delay start .....	39
Changing a programme and settings.....	39
Cancelling Delay start and beginning the programme straight away.....	39
<b>Programme chart</b> .....	40
<b>Extra options</b> .....	45
ProgrammeManager.....	45
Intensive .....	45
ECO .....	45
Extra gentle .....	45
Extra quiet .....	45
AllergoWash .....	45
Short.....	46
Water plus .....	46
Stains.....	46
Wash programme chart - ProgrammeManager.....	47
<b>Garment care label symbols</b> .....	49
<b>Programme sequence</b> .....	50
<b>Changing the programme sequence</b> .....	52
Cancelling a programme .....	52
Interrupting a programme.....	52
Changing a programme and settings.....	52
Adding or removing laundry after a programme has started .....	53
Safety lock.....	54
<b>Detergent</b> .....	55
The correct detergent.....	55
Detergent dispensing aids.....	55
Fabric softeners and liquid starch .....	55
Miele recommended detergents .....	56
<b>Cleaning and care</b> .....	60
Cleaning the drum (Hygiene info) .....	60
External casing and fascia panel.....	60
Cleaning the detergent dispenser drawer .....	60
Cleaning the TwinDos system .....	62
Cleaning the water inlet filter.....	63

# Contents

---

<b>Problem solving guide</b> .....	64
Problem solving guide .....	64
The programme does not start .....	64
The following fault message appears in the display and the programme has been cancelled .....	65
The following fault message appears in the display at the end of a programme..	66
Problems with TwinDos .....	68
General problems with the washing machine .....	69
An unsatisfactory wash result .....	71
The door will not open .....	72
Opening the door in the event of a blocked drain outlet and/or power cut .....	73
<b>After sales service</b> .....	75
Repairs .....	75
Optional accessories .....	75
Warranty .....	75
<b>Installation and connection</b> .....	76
Front view .....	76
Rear view .....	77
Installation surface .....	78
Transporting the washing machine to its installation site .....	78
Removing the transit bars .....	78
Refitting the transit bars .....	80
Levelling the machine .....	81
Screwing out and adjusting the feet .....	81
Building under a continuous worktop / in a kitchen run .....	82
Washer and dryer stack .....	82
The Miele water protection system .....	83
Connection to the water supply .....	85
Drainage .....	87
Electrical connection .....	88
<b>Consumption data</b> .....	89
Consumption data for the nominated energy labelling programme according to AS/NZS 2040.1 & AS/NZS 2040.2 .....	89
<b>Technical data</b> .....	91

---

<b>Settings</b> .....	92
Language  .....	93
Detergent/Amount .....	93
Degree of soiling .....	93
Buzzer volume .....	93
Keypad tone .....	93
Total consumption .....	93
PIN Code .....	94
Temperature unit .....	94
Display brightness .....	94
Dark display .....	94
Appliance switch-off status .....	95
Memory .....	95
Water intake .....	95
Pre-wash Cottons .....	96
Gentle action .....	96
Reduce temp. .....	96
Water plus .....	96
Water plus level .....	97
Maximum rinse level .....	97
Suds cooling .....	97
Anti-crease .....	97
<b>Optional accessories</b> .....	98
Detergent .....	98
Specialist detergents .....	98
Fabric care .....	99
Additives .....	99

# Caring for the environment

---

## Disposal of the packing material

The transport and protective packaging has been selected from materials which are environmentally friendly for disposal, and can normally be recycled.

Recycling the packaging reduces the use of raw materials in the manufacturing process and also reduces the amount of waste in landfill sites. Ensure that any plastic wrappings, bags etc. are disposed of safely and kept out of the reach of babies and young children. Danger of suffocation.

## Disposing of your old appliance

Electrical and electronic appliances often contain valuable materials. They also contain specific materials, compounds and components, which were essential for their correct function and safety. These could be hazardous to human health and to the environment if disposed of with your domestic waste or if handled incorrectly. Please do not, therefore, dispose of your old appliance with your household waste.



Please dispose of it at your local community waste collection / recycling centre for electrical and electronic appliances. You are also responsible for deleting any personal data that may be stored on the appliance prior to disposal. Please ensure that your old appliance poses no risk to children while being stored prior to disposal.

## Warning and Safety instructions

This washing machine complies with current safety requirements. Inappropriate use can, however, lead to personal injury and damage to property.

To avoid the risk of accidents and damage to the machine, please read these instructions carefully before using it for the first time. They contain important information on its safety, use and maintenance.

Keep these instructions in a safe place and ensure that new users are familiar with the content. Pass them on to any future user.

### Correct application

- ▶ This washing machine is designed for domestic use and for use in similar environments by guests in hotel or motel rooms, bed & breakfasts and other typical living quarters. This does not include common/shared facilities or commercial facilities within hotels, motels or bed & breakfasts.
- ▶ The washing machine is not suitable for outdoor use.
- ▶ It must only be used to wash garments which have been declared suitable for washing by the manufacturer indicated on the garment care label. Any other use is not permitted. Miele cannot be held liable for damage resulting from incorrect or improper use or operation.
- ▶ This washing machine is not intended for use by persons (including children) with reduced physical, sensory or mental capabilities, or lack of experience and knowledge, unless they have been given supervision or instruction concerning its use by a person responsible for their safety.

# Warning and Safety instructions

---

## Safety with children

- ▶ Young children must not be allowed to use this appliance.
- ▶ Older children may only use the appliance when its operation has been clearly explained to them and they are able to use it safely, recognising the dangers of misuse.
- ▶ Cleaning work may only be carried out by older children under the supervision of an adult.
- ▶ Please supervise children in the vicinity of the washing machine and do not let them play with it.

## Technical safety

- ▶ Please observe the instructions in "Installation and connection" and "Technical data".
- ▶ Before setting up the washing machine, check it for any externally visible damage. Do not install or use a damaged machine.
- ▶ Before connecting the washing machine, ensure that the connection data on the data plate (fuse rating, voltage and frequency) matches the mains electricity supply. If in any doubt, consult a qualified electrician.
- ▶ Reliable and safe operation of this washing machine can only be assured if it has been connected to the mains electricity supply.



## Warning and Safety instructions

---

- ▶ The electrical safety of this washing machine can only be guaranteed when continuity is complete between it and an effective earthing system which complies with current local and national safety regulations. It is most important that this basic safety requirement is present and regularly tested and, where there is any doubt, the household wiring system should be inspected by a qualified electrician. Miele cannot be held liable for the consequences of an inadequate earthing system (e.g. electric shock).
- ▶ Do not connect the washing machine to the mains electricity supply by a multi-socket adapter, extension lead or similar. These do not guarantee the required safety of the machine (fire hazard due to the risk of overheating).
- ▶ Faulty components must only be replaced by genuine Miele spare parts. Miele can only guarantee the safety of the appliance when Miele replacement parts are used.
- ▶ The electrical socket must be easily accessible after installation so that the machine can be disconnected from the electricity supply if necessary.
- ▶ Unauthorised repairs could result in unforeseen dangers for the user, for which Miele cannot accept liability. Repairs should only be undertaken by a Miele authorised service technician, otherwise any subsequent damage will not be covered by the warranty.
- ▶ If the connection cable is faulty, it must only be replaced by a Miele approved service technician to protect the user from danger.

## Warning and Safety instructions

---

- ▶ In the event of a fault or for cleaning purposes, the washing machine is only completely isolated from the electricity supply when:
  - it is switched off at the wall socket and the plug is withdrawn, or
  - it is switched off at the mains circuit breaker.
- ▶ The Miele Waterproof system protects from water damage provided the following conditions have been met:
  - The machine is correctly plumbed in and connected to the electricity supply.
  - If a fault or damage has been identified, the machine must be examined by a competent person before further use, and repaired if necessary.
- ▶ The water flow pressure must be at least 100 kPa and should not exceed 1000 kPa.
- ▶ This washing machine must not be installed and operated in mobile installations (e.g. on a ship).
- ▶ In areas which may be subject to infestation by cockroaches or other vermin, pay particular attention to keeping the machine and its surroundings in a clean condition at all times. Any damage which may be caused by cockroaches or other vermin will not be covered by the machine warranty.
- ▶ Do not make any alterations to the machine, unless authorised to do so by Miele.

### Correct use

- ▶ Do not install the washing machine in a room where there is a risk of frost. Frozen hoses may burst or split. The reliability of the electronic control unit may be impaired at temperatures below freezing point.
- ▶ Before using the machine for the first time, check that the transit bars at the rear of the machine have been removed (see "Installation and connection - Removing the transit bars"). During spinning, a transit bar which is still in place may result in damage to both the machine and adjacent furniture or appliances.
- ▶ Turn off the tap if the machine is to be left for any length of time (e.g. holiday), especially if there is no floor drain (gully) in the immediate vicinity.
- ▶ Flooding danger.  
If hooking the drain hose into a wash basin, check that the water can drain off quickly enough to prevent the sink from overflowing. Make sure the drain hose is secure, so that the force of the water flowing out of the hose does not dislodge it.
- ▶ Take care to ensure that foreign objects (e.g. nails, pins, coins, paper clips) do not find their way into the machine with the laundry. These may damage components of the machine (e.g. suds container, drum), which in turn can result in damage to the laundry.

## Warning and Safety instructions

---

- ▶ Take care when opening the drum door after using the steam function. There is a danger of burning due to escaping steam and the high temperature of the surface of the drum as well as the porthole glass. Stand back away from the machine and wait until the steam has dissipated.
- ▶ The maximum load for this washing machine is 8 kg (dry weight). See the "Programme chart" for the maximum recommended loads for individual programmes.
- ▶ If the correct amount of detergent is dispensed, the machine should not need to be descaled. If, however, you do wish to descale it, only use a proprietary natural citric acid based descaling agent. Miele recommends using Miele descaler for washing machines which is available to order online at [www.miele-shop.com](http://www.miele-shop.com) (depending on country) or from Miele. Strictly observe the instructions on the packaging.
- ▶ Textiles which have been pre-treated in solvent based cleaning agents must be thoroughly rinsed in clean water before being washed in the machine.
- ▶ Do not use solvent based cleaning agents, e.g. those containing benzene, in this machine, as this may result in damage to component parts and create toxic fumes. Such agents also pose a fire and explosion hazard.
- ▶ Do not use solvent based cleaning agents, e.g. those containing benzene, to clean the external surfaces of the machine. They can cause damage to plastic surfaces.
- ▶ Only use dyes specified by the manufacturer as being suitable for use in a domestic washing machine. Always observe the manufacturer's instructions carefully.

## Warning and Safety instructions

---

- ▶ Colour run and dye removers contain sulphur compounds which can cause damage such as corrosion. Do not use these products in this machine.
- ▶ If detergent comes into contact with the eyes, rinse them thoroughly with lukewarm water immediately. If swallowed, seek medical assistance immediately and retain the packaging or label for reference. Those with skin problems or sensitive skin should avoid their skin coming into contact with detergent.

### Accessories

- ▶ Only use genuine Miele spare parts and accessories with this appliance. If spare parts or accessories from other manufacturers are used, this will invalidate the warranty, and Miele cannot accept liability.
- ▶ A Miele tumble dryer can be stacked on top of a Miele washing machine using the appropriate stacking kit (available as an optional accessory). Please make sure you order the correct one for the Miele washing machine and Miele tumble dryer.

Miele cannot be held liable for damage caused by non-compliance with these Warning and Safety instructions.

# Operating the washing machine

## Control panel

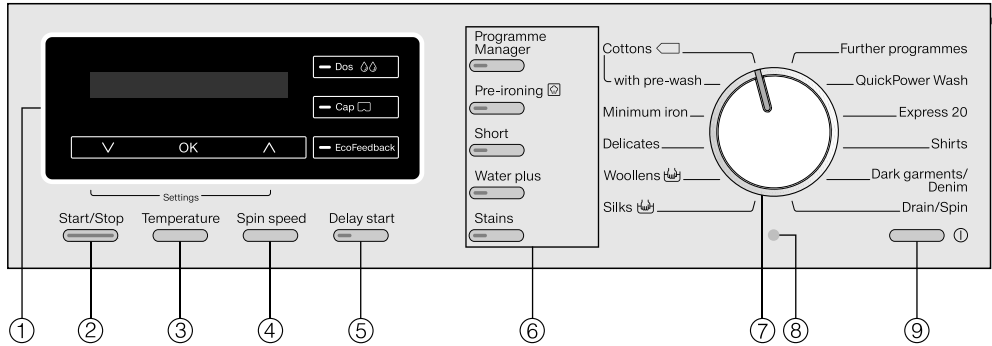

- ① **Display with sensors**  
See the next page for more information.
- ② **Start/Stop button**  
For starting the programme selected and cancelling a programme once it has started.
- ③ **Temperature button**  
For selecting the temperature.
- ④ **Spin speed button**  
For selecting the spin speed.
- ⑤ **Delay start button**  
For selecting Delay start.
- ⑥ **Extra option buttons**  
Various options can be added to the wash programmes.
- ⑦ **Programme selector**  
For selecting the wash programme.
- ⑧ **PC optical interface**  
For service technicians.
- ⑨ **⏻ button**  
For switching the washing machine on and off.  
To save energy, the washing machine will switch off automatically 15 minutes after the end of the programme / Anti-crease phase or after being switched on if no other selection is made.

# Operating the washing machine

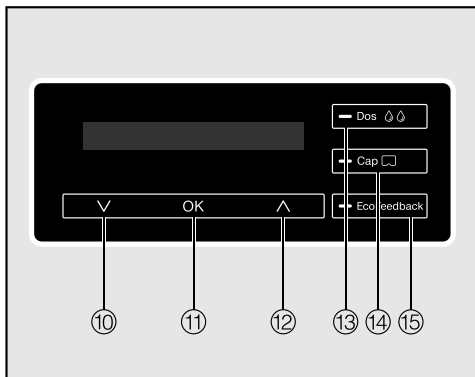

- ⑩ **Sensor** ∇  
Scrolls down the selection list to the next option or decreases a value.
- ⑪ **OK sensor**  
Confirms the programme selected, a value set or opens a sub-menu.
- ⑫ **Sensor** ^  
Scrolls up the selection list to the next option or increases a value.
- ⑬ **💧 Dos sensor**  
Switches on automatic detergent dispensing.
- ⑭ **🗑️ Cap sensor**  
Activates cap dosing via the detergent dispenser drawer.
- ⑮ **EcoFeedback sensor**  
Provides information about the energy and water consumption of the programme. Please also refer to "Washing environmentally and economically - EcoFeedback".

Sensors ⑩ to ⑫ light up when the display can be operated via the sensors.

## Programme duration

After the programme has started, the programme duration will appear in the display in hours and minutes.

When Delay start is being used, the programme duration will appear after the Delay start time has elapsed.

## Delay start

The Delay start time selected will appear in the display.

After the programme has started, the Delay start time will begin to count down.

Once the Delay start time has finished, the programme begins and the estimated programme duration appears in the display.

# Operating the washing machine

---

## Standard display

The standard display shows the following from left to right:





- Programme duration
- The selected wash temperature
- The selected spin speed

## Examples on how to operate the appliance

### Scrolling through a list

The  arrows in the display indicate that a selection is available.



Touching the  sensor scrolls down the list to the next option and touching the  sensor scrolls up the list to the next option. The *OK* sensor is used to activate the option which is currently in the display.



### Identifying options selected



An option which has been activated will have a tick  next to it.

## Setting numerical values



A numerical value is highlighted in white. Touching the  sensor decreases the value and touching the  sensor increases it. The *OK* sensor is used to activate the value in the display.

### Leaving a sub-menu

Select *Back*  to exit a sub-menu.



## Before using for the first time

 Before using the machine for the first time, ensure that it is correctly installed and connected. See "Installation and connection". Also check that the filters are securely tightened to prevent the risk of water leaks during use.

### Removing the protective foil and stickers

- Please remove
  - the protective foil from the door.
  - any stickers from the front and the lid (Exception: warning labels must not be removed).

 Please do not remove any labels (e.g. the data plate) which are visible when you open the door.

### Removing the detergent cartridges from the drum

There are two cartridges in the drum containing UltraPhase 1 and UltraPhase 2 detergent for automatic detergent dispensing.

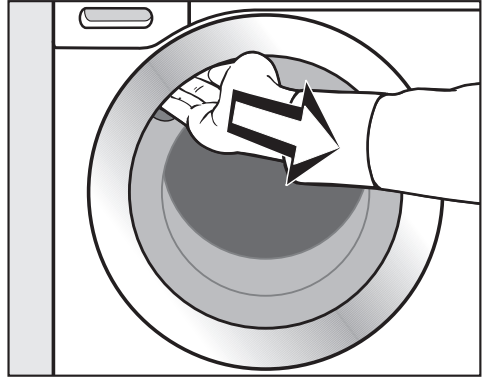

- Reach under the door grip and pull the door open.
- Take the two cartridges out of the drum.

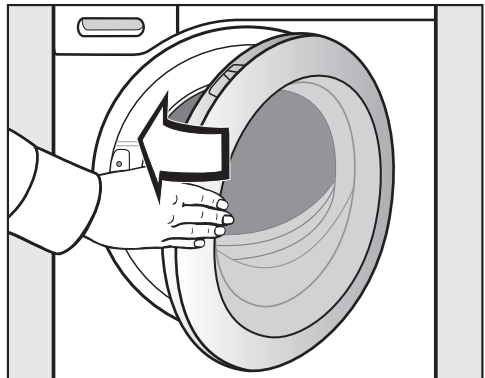

- Shut the door with a gentle swing.

## Before using for the first time

---

This washing machine has undergone a complete functional test at the factory and there will be some residual water in the drum from this process.

For safety reasons, spinning is not possible until the machine has been prepared for use for the first time. To activate the spinning function, you must run a wash programme without laundry and without detergent.

Using detergent could result in an excessive build-up of foam.

- Press the ⓘ button in.

The welcome screen will light up.

### Setting the language

You will be asked to select the language you want for the display. It is possible to change the language at any time via "Settings".



- Touch the ∨ or ∧ sensor until the language you want appears in the display.
- Confirm your selection of the language by touching the *OK* sensor.

### Messages

Two messages about removing the transit bars and preparing the washing machine for use will appear in the display.

- Ensure the feet of the washing machine are aligned and the transit bars have been removed, and confirm the messages with the *OK* sensor.

### Running the first programme

The TwinDos unit needs to be activated before running the first programme.

- Please see "TwinDos".

The washing machine has an integrated detergent dispensing unit.

The detergent dispensing unit can be used with

1. the Miele 2 Phase System  
or
2. any other liquid detergent and/or fabric softener

## The Miele 2 Phase System

The Miele 2 Phase System uses a base detergent (UltraPhase 1) and a detergent enhancer (UltraPhase 2). In order to achieve optimum results, the agents are dispensed separately during the wash process. The 2 Phase System cleans both white and coloured textiles thoroughly. UltraPhase 1 and UltraPhase 2 single use cartridges are available to order from Miele or via the internet at [www.miele-shop.com](http://www.miele-shop.com) (depending on country).

## Liquid detergent/Fabric softener

Refillable TwinDos containers are required for liquid detergent and/or fabric softener. These are available to order from Miele or via the internet at [www.miele-shop.com](http://www.miele-shop.com) (see end of this booklet for details).

## How TwinDos works

Automatic detergent dispensing for a wash cycle is activated via the *Dos*  sensor.

To use the TwinDos function, you need to specify the following information for the electronic unit:

1. The **detergent type** and/or **fabric softener** with which the containers are filled.
2. The **dosage amount** of the liquid detergent and/or fabric softener. The dosage amount for Miele products is preset at the factory.

Do not fill the containers with any specialist detergents. Use cap dosing or the detergent dispenser drawer for these.

Automatic dispensing cannot be selected with some programmes, depending on the detergent present in the TwinDos system. For example, automatic dispensing cannot be activated for the Woollens programme if the Miele 2 Phase System is being used. This prevents woollen garments being damaged by a detergent which is not suitable for washing wool.

# TwinDos

## Inserting detergent cartridges

The detergent cartridges are the components of the Miele 2 Phase System which consists of:

1. UltraPhase 1 (base detergent)
2. UltraPhase 2 (detergent enhancer)

These detergent cartridges are for single use only. Replacement detergent cartridges are available to order from Miele or via the internet at [www.miele-shop.com](http://www.miele-shop.com) (see end of this booklet for details). Empty cartridges should be disposed of via your local recycling system.

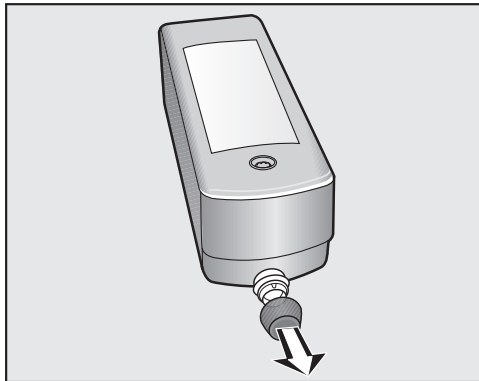

- Remove the stoppers from the detergent cartridges.

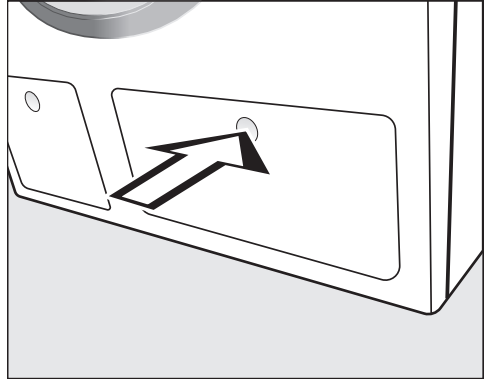

- Press the TwinDos access panel.

The panel will spring open.

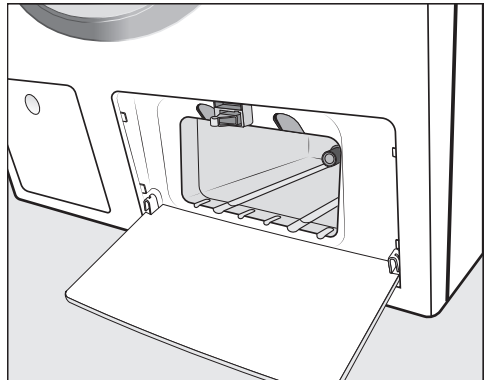

- Open the panel.

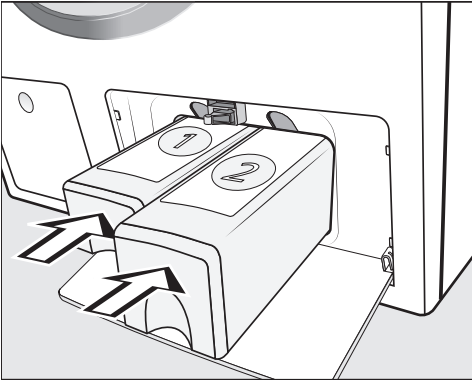

- Push the **UltraPhase 1** cartridge into **compartment 1** and the **UltraPhase 2** cartridge into **compartment 2**, until they lock into position.

The TwinDos system is now ready for use.

## Using containers

Refillable TwinDos containers are required for liquid detergent and/or fabric softener. These are available to order from Miele or via the internet at [www.miele-shop.com](http://www.miele-shop.com) (see end of this booklet for details).

- Open the yellow stopper and fill the container with your detergent of choice.
- Close the stopper and push the container back into the compartment. Make sure that the lock engages.

**Useful tip:** Make a note of which detergents you have filled the containers with so that you then enter the correct settings in the electronics later on.

The following liquid detergents and/or fabric softeners can be used in the containers:

- Miele UltraColor
- Miele WoolCare
- Miele fabric softener
- Universal detergent
- Colour detergent
- Delicates detergent
- Woollens detergent
- Fabric softener

# TwinDos

## Opening the Settings menu

You have to enter the type of detergent being used in the *Settings* menu.

- Switch on the washing machine and wait until the standard display lights up.

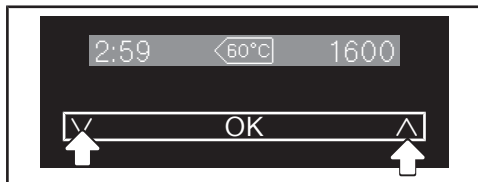

- Touch the ∨ and ∧ sensors at the same time until the following appears in the display:



The "Settings" menu has been opened.

- Touch the ∨ sensor until the following appears in the display:



- Touch the *OK* sensor.



- Touch the *OK* sensor.

## Settings for UltraPhase 1 and UltraPhase 2

The dosage amounts for UltraPhase 1 and UltraPhase 2 are preset for normal soiling and need only be confirmed.



- Touch the *OK* sensor.



- Use the ∨ or ∧ sensor to select UltraPhase 1 and confirm your choice with the *OK* sensor.



- Use the *OK* sensor to confirm the dosage amount.

The washing machine will automatically assign UltraPhase 2 to compartment 2. You just need to confirm the dosage amount.



- Use the *OK* sensor to confirm the dosage amount.

## Settings for other types of detergent

The dosage amounts for Miele products (UltraColor liquid, WoolCare etc.) are preset for normal soiling and need only be confirmed.

Container 1 

- Touch the *OK* sensor.

No entry  

- Touch the  $\nabla$  or  $\blacktriangle$  sensor to select the type of product being used and confirm with the *OK* sensor.

Dosage amount  ml

- Use the *OK* sensor to confirm the dosage amount.
- Set compartment 2 as described above.

When adding universal liquid detergent or liquid colour detergent, do not load more than 8 kg of laundry, and when adding liquid detergent for wool and delicates, do not load more than 2.5 kg of laundry.

**Useful tip:** If you need to set a different dosage amount for Miele products due to lighter or heavier soiling, refer to the label on the Miele detergent bottle. Please note that one cap is equal to 40 ml.

# TwinDos

## Running the first programme

The TwinDos system needs to be primed before you can use the washing machine.

To do this, you **must** run a wash programme **without** laundry.

- Turn on the tap.
- Turn the programme selector to *Cottons*.

The following will appear in the display:

Load 1 - 8 kg

The standard display will then appear:

3:10 60°C 1600

- Touch the *Dos* sensor.

The following will appear in the display:

Degree of soiling

The display will change automatically to the degree of soiling query:

Normal ■■■

- Select the *Heavy* degree of soiling setting with the  $\wedge$  sensor and confirm your selection with the OK sensor.

If the Miele 2 Phase System is being used, a query about the colour mix of the items will also appear.

Miele DuoWhite

- Confirm the Miele DuoWhite option with the OK sensor.
- Press the *Start/Stop* button.
- Switch the washing machine off at the end of the programme.

The TwinDos unit is now ready for use.



# Washing environmentally and economically

---

## Energy and water consumption

- Water consumption and energy usage are determined by the size of the load.  
To make the most out of your machine, load the maximum dry load for the programme you are using.
- When smaller amounts of laundry are washed, the automatic load recognition system will reduce the amount of water and energy used.
- Use the *Express 20* programme for small, lightly soiled loads.
- Modern detergents make it possible to wash at lower temperatures (e.g. 20°C). Washing using lower temperature settings will save energy.
- To maintain the hygiene of the machine, carry out a hot wash (above 60°C) using powder detergent at regular intervals. Hygiene info will appear in the display to remind you to carry out a hot wash.
- Use the hot water connection to save energy.

## Detergent consumption

- For precise dispensing, use automatic detergent dispensing.
- Adjust the dosage to the degree of soiling of the laundry.
- Do not exceed the amounts of detergent recommended by the manufacturer on the packaging.

## When drying with a tumble dryer

Selecting the highest possible spin speed for the wash programme will save energy when drying in a tumble dryer afterwards.

# Washing environmentally and economically

## EcoFeedback

You can call up information about the energy and water consumption of your washing machine with the *EcoFeedback* sensor.

The following information will appear in the display:

- An estimate of the consumption before the programme begins.
- The energy and water consumption used thus far in a current programme.
- The energy and water consumption of the programme which has just finished.

### 1. Estimate

- After selecting a programme, touch the *EcoFeedback* sensor.

The estimated energy consumption levels will be displayed as a bar chart.



- Touch the  $\nabla$  or  $\blacktriangle$  sensor to change to the estimated water consumption levels.



The more bars (■) visible, the higher the energy or water consumption.

The estimate will vary depending on the wash programme, temperature and any Extra options selected.

The display will change automatically or you can return to the standard display by touching the *OK* sensor.

## 2. Actual consumption

**Useful tip:** At the end of the programme, before opening the door, you can view the actual amount of energy and water used by the programme which has just been run.

- Touch the *EcoFeedback* sensor.



- Touch the  $\nabla$  or  $\blacktriangle$  sensor to switch to the water consumption display.

If the door is opened or the washing machine has switched off automatically at the end of the programme, the data will revert to the estimated consumption.

### Total consumption setting

- This setting gives a total of the energy consumption and water consumption to date.

See "Settings".

# 1. Preparing the laundry

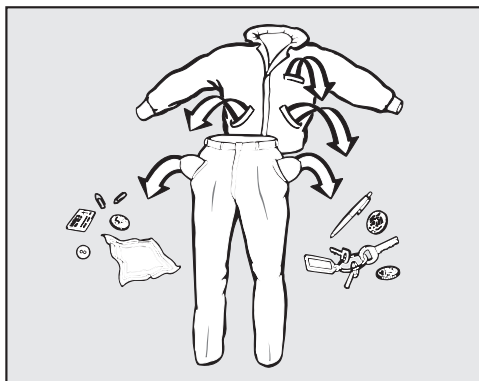

- Empty all pockets.

⚠ Foreign objects (e.g. nails, coins, paper clips, etc.) can cause damage to garments and components in the machine.

## Sorting the laundry

- Sort the laundry by colour and by care label. Most garments have a textile care label in the collar or side seam.

**Useful tip:** Dark textiles often contain excess dye and should be washed separately several times before being included in a mixed load. Always wash white and coloured items separately.

## Pre-treating stains

- Badly soiled areas, stains etc. should be cleaned as soon as possible, preferably while still fresh. Spillages should be carefully dabbed off using a soft, colourfast cloth. Do not rub.

**Useful tip:** Stains can be pre-treated using some handy tricks, which can be found in "Miele's guide to laundry care". Please contact Miele to obtain a copy of this booklet.

⚠ If you use a solvent-based cleaning agent (e.g. one containing benzene) to pre-treat a stain, make sure that any plastic parts (e.g. buttons) are protected, and that the cleaning agent is rinsed off before washing the garment in the machine.

⚠ Do not use solvent-based cleaning agents in or on this machine.

## General tips

- Curtains: Remove lead weights first or place in a laundry bag.
- Underwiring and collar stiffeners: Any loose wiring in bras, shirt collar stiffeners, etc. should be removed or sewn in.
- Close any zips, attach velcro fasteners, fasten hooks and eyes etc. before washing.
- Fasten duvet covers and pillow cases to prevent small items from being rolled up inside them.

Do not wash any items in this machine which are specified by the manufacturer as **not washable** on the care label (☒ symbol).

## 2. Selecting a programme

### Switching on the washing machine

- Press the  button.

### Programme selection

#### A. Selecting a programme via the programme selector:

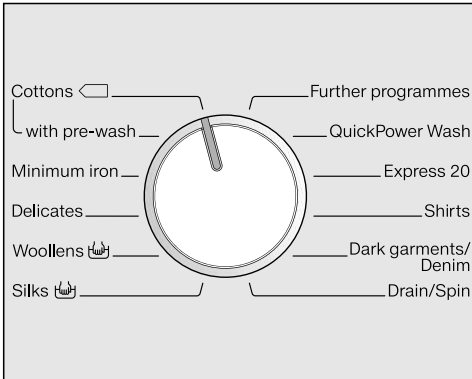

- Turn the programme selector to the required programme.

The load for the programme selected will appear in the display. This will then be replaced by the standard display.

#### B. Selecting a programme using the programme selector at the "Further programmes" position and the display:

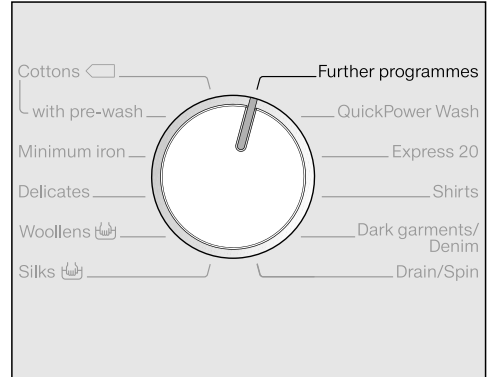

- Turn the programme selector to the *Further programmes* setting.

The following appears in the display:



- Touch the  $\nabla$  or  $\blacktriangle$  sensor until the programme you want appears in the display.
- Confirm the programme with the *OK* sensor.

The load for the relevant programme will appear in the display. Preset programme parameters will be displayed, depending on the programme selected.

### 3. Loading the washing machine

#### Opening the door

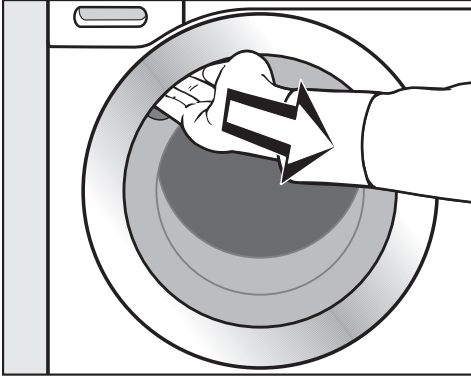

- Reach under the door grip and pull the door open.

Check the drum for pets or foreign objects before loading it with laundry.

- Unfold the laundry and load loosely in the drum.

Mixing both large and small items gives better wash results and also helps distribute the load evenly during spinning.

Please note the maximum load for the different wash programmes. The relevant programme load is always shown in the display when you select a programme.

The most efficient use of energy and water is achieved when a full load is washed. However, do not overload as this reduces cleaning efficiency and causes creases.

#### Closing the door

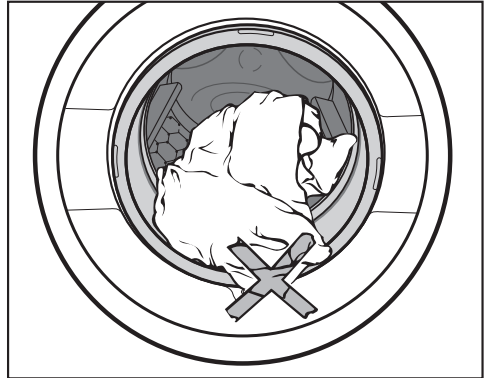

- Make sure that no items are caught between the door and the seal.

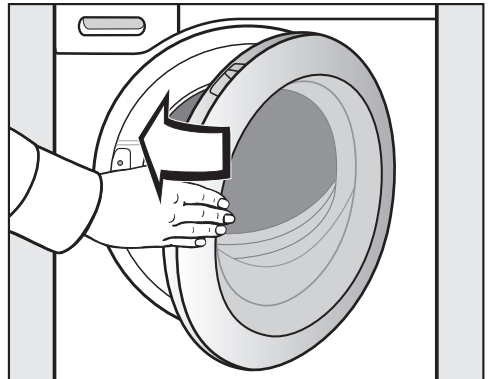

- Shut the door with a gentle swing.

## 4. Selecting programme settings

### Degree of soiling

#### Lightly soiled

No visible dirt or stains. Possibly slight body odour.

#### Normally soiled

Visibly dirty and/or just a few slight stains.

#### Heavily soiled

Stains and soiling clearly visible.

The following appears in the display:

A dark grey rectangular display area with the text "Degree of soiling" in white.

The display will change automatically to the degree of soiling query:

A dark grey rectangular display area with the text "Normal" in white, followed by three vertical bars and a square icon.

- Set the degree of soiling with the ∨ and ∧ sensors and confirm your selection with the OK sensor.

The following parameters will change, depending on the degree of soiling selected:

- The detergent dosage amount with automatic detergent dispensing.
- With the *Heavy* degree of soiling setting, a pre-wash will be carried out automatically for some programmes (see "Extra options").
- The rinse water level will be adjusted.
- The programme durations (with light soiling the programme duration will be shorter).

The degree of soiling cannot be selected for some programmes. These programmes are designed for moderately soiled laundry.

**Useful tip:** You can alter the default setting for the degree of soiling or switch off the degree of soiling query in Settings (see "Settings - Degree of soiling").

### Selecting a temperature

You can alter the preset temperature of a wash programme.

- Press the *Temperature* button.

The following will appear in the display:

A dark grey rectangular display area with the text "Temperature" in white.

A white rectangular box with a left-pointing arrow, containing the text "60°C", followed by a smaller "°C" symbol.

- Set the temperature you want with the ∨ and ∧ sensors and confirm your selection with the OK sensor.

## 4. Selecting programme settings

### Selecting a spin speed

You can alter the preset spin speed of a wash programme.

- Press the *Spin speed* button.

The following will appear in the display:

Spin speed 1600 rpm

- Set the spin speed you want with the  $\nabla$  and  $\wedge$  sensors and confirm your selection with the *OK* sensor.

### Selecting Extra options



- Press the button for the Extra option you want.

The indicator light in the button will come on.

Not all Extra options are suitable for use with every programme. You can only select options which are compatible with the programme being used (see "Extra options").

### Switching on Delay start

The start of a programme can be delayed from 15 minutes up to 24 hours, allowing you to make use of night-time economy electricity rates, for example (see "Delay start").

## 5. Adding detergent

There are several options for adding detergent.

### TwinDos

Depending on which agents have been added in compartments 1 and 2:

#### Miele 2 Phase System

The optimum amount of UltraPhase 1 and UltraPhase 2 will be dispensed automatically according to the colour mix of the load.

- Press the *Dos*  sensor.

Depending on the programme selected, the following will appear in the display:

Miele DuoWhite 

- Use the  $\nabla$  and  $\wedge$  sensors to select the dosage mix (for whites or for coloured items) and confirm your selection with the *OK* sensor.

Base detergent and detergent enhancer will be dispensed in the appropriate dosage mix at the ideal time during the wash cycle.

### Liquid detergent/Fabric softener

The most suitable agent will appear in the display with a tick (✓) beside it.

If both the agents present in the containers are suitable (e.g. detergent for coloured items and fabric softener), then both agents will be selected.

Both detergents ✓ 

- Confirm the option displayed with the *OK* sensor or select another detergent or fabric softener with the  $\nabla$  and  $\wedge$  sensors.

Detergent and/or fabric softener will now be dispensed in accordance with the wash cycle.

### Adding stain remover

There are two options for adding stain remover in addition to using the automatic dispensing system:

- Use cap dosing.
- Add the stain remover to the  compartment.



## 5. Adding detergent

### Detergent dispenser drawer

#### Too little detergent results in:

- laundry not getting properly clean and with time it may become grey and hard to the touch.
- greasy particles clinging to the laundry.
- limescale deposits on the heater elements.

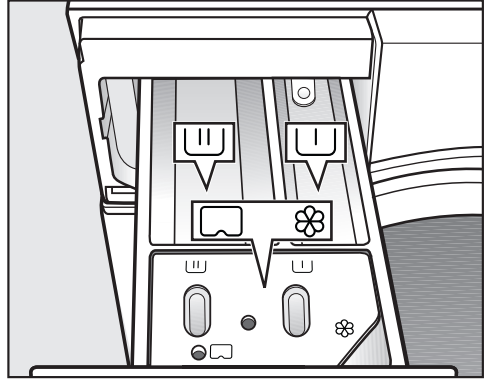

#### Too much detergent results in:

- excessive foam which causes a low level of agitation and poor wash, rinse and spin results.
- high water consumption (an additional rinse cycle will automatically switch in).
- a burden to the environment.



- Pull out the detergent drawer and add detergent to the compartments.



Detergent for the pre-wash (divide the total recommended amount as follows: add  $\frac{1}{3}$  to compartment  and  $\frac{2}{3}$  to compartment )



Detergent for the main wash



Fabric softener, liquid starch or capsules.

See "Detergent" for further information.

# 5. Adding detergent

## CapDosing

Three different types of capsule are available:

- ☼ = Fabric care (e.g. fabric softener)
- ☼☼ = Additives (e.g. detergent enhancers)
- ☼ = Detergent (for the main wash only)

Each capsule contains the correct amount for one wash cycle.

You can order the capsules online at [www.miele-shop.com](http://www.miele-shop.com) (depending on country) or from Miele (see the end of this booklet for contact details).

⚠ Keep capsules out of the reach of children.

## Activating CapDosing

- Touch the *Cap* ☼ sensor.

The first type of capsule which can be selected for the programme will appear in the display.



- Select the type of capsule you want with the ∨ and ∧ sensors and confirm your selection with the OK sensor.

## Inserting a capsule

- Open the detergent dispenser drawer.

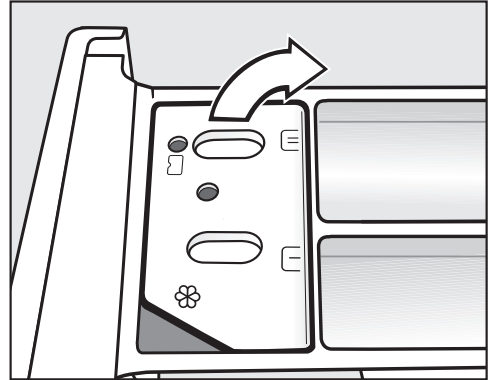

- Open the lid of the ☼☼ compartment.

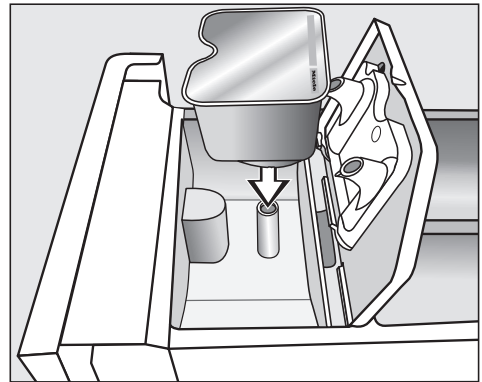

- Press the capsule in firmly.

## 5. Adding detergent

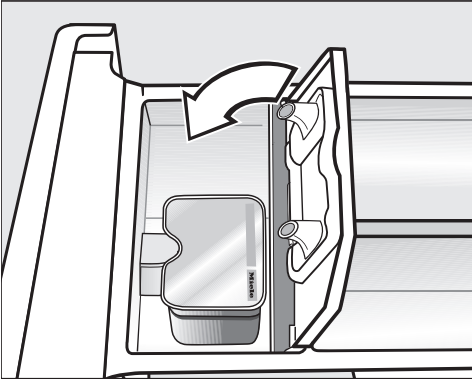

- Close the lid and press it firmly shut.
- Close the detergent dispenser drawer.

The capsule is opened by the act of inserting it in the detergent dispenser drawer. The contents can run out of the capsule if you then remove it from the drawer before it is used. In this case, dispose of the capsule and do not re-use it.

The wash programme will dispense the contents of the capsule at the correct time.

Water intake to the ☼ compartment is solely via the capsule.

No additional fabric softener may be added to the ☼ compartment when using a capsule.

- Remove the empty capsule at the end of the programme.

For technical reasons a small amount of water will remain in the capsule.

### Deactivating/Changing CapDosing

- Touch the *Cap*  sensor and follow the instructions in the display.

## 6. Starting the programme - the end of the programme

### Starting the programme

- Press the flashing *Start/Stop* button.

The door will lock (🔒 will appear in the display to show this) and the programme will start.

If a Delay start time has been selected, then this will count down in the display. At the end of the Delay start time or immediately after the programme has started (if no Delay start time has been selected), the programme duration will appear in the display.

The programme sequence is also shown in the display. The washing machine lets you know which section of the programme has been reached.

### At the end of the programme

The door is still locked during the Anti-crease phase and the following will appear alternately in the display:

Anti-crease/Finish

and

**i** Press Start/Stop

- Press the *Start/Stop* button. This will unlock the door.
- Pull open the door.
- Remove the laundry.

Items left in the drum could discolour other items in the next wash or become discoloured themselves. Check that all items have been removed from the drum.

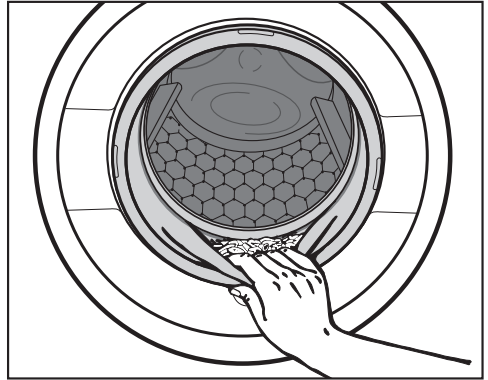

- Check the folds in the door seal for any small articles, e.g. buttons, which might be lodged there.
- Close the door. Otherwise there is a danger of objects being placed inadvertently in the drum. If these remained unnoticed and were washed in the next load, they could damage the laundry. An open door is also a danger to pets and children.
- Switch the washing machine off with the ⏻ button.
- If applicable, remove the used capsule from the detergent dispenser drawer.

**Useful tip:** Leave the detergent dispenser drawer slightly open to allow it to dry.

## Final spin speed

Programme	rpm
Cottons	1600
Minimum iron	1200
Delicates	900
Woolens 	1200*
Silks 	600*
Automatic plus	1400
Down duvets	1200
Outerwear	800
Proofing	1000
Sportswear	1200
Separate rinse / Starch	1600*
Clean machine	900
QuickPowerWash	1600*
Express 20	1200
Shirts	900
Darks / Denim	900
Drain/Spin	1600

## Final spin speed in the programme

When a programme is selected, the optimum spin speed for that programme will appear in the display. For programmes marked with a \* in the chart, the optimum spin speed is not the maximum spin speed.

You can reduce the final spin speed.

However, you cannot select a final spin speed higher than that shown in the chart.

## Rinse and interim spin

There is a spin after the main wash and between the rinses. A reduction in the final spin speed will also reduce the interim spin speed. If a spin speed of less than 700 rpm is selected for the *Cottons* programme, an additional rinse is introduced.

# Spinning

---

## Omitting the final spin (Rinse hold)

- Use the *Spin speed* button to select the  setting (Rinse hold). The laundry is not spun after the final rinse and remains in the final rinse water. This helps prevent creasing if the laundry is not going to be removed from the drum immediately after the end of the programme.
- To start the final spin:  
The washing machine will display the maximum spin speed possible. You can select a spin speed lower than this. Start the final spin by pressing the *Start/Stop* button.
- To end the programme:  
Use the *Spin speed* button to select the 0 rpm setting (Without spin) and press the *Start/Stop* button.

The water will drain away.

## Omitting rinse and interim spin and the final spin

- Press the *Spin speed* button.
- Select the 0 rpm setting.

After the last rinse, the water will be pumped away and the Anti-crease phase will switch in.

In some programmes an additional rinse is introduced with this setting.

With Delay start you can choose when you want the programme to start. You can delay the start of the programme from 15 minutes up to a maximum of 24 hours, allowing you to make use of night-time economy electricity rates, for example.

## Selecting Delay start

- Press the *Delay start* button.

The following will appear in the display:



- Use the  $\nabla$  and  $\wedge$  sensors to enter the hour and confirm your entry with the *OK* sensor.

The display will change:



- Use the  $\nabla$  and  $\wedge$  sensors to enter the minutes and confirm your entry with the *OK* sensor.

**Useful tip:** The values will count upwards and downwards automatically if you touch the  $\nabla$  or  $\wedge$  sensor continuously.

## Beginning Delay start

- Press the *Start/Stop* button to begin Delay start and the wash programme.

The following will appear in the display:



When the Delay start time has elapsed, the programme will begin and the display will show the programme duration and the programme sequence.

## Changing a programme and settings

You can change Delay start at any time.

- Press the *Delay start* button.



- Touch the *OK* sensor.



- Now enter the time you want the programme to start.

## Cancelling Delay start and beginning the programme straight away

- Press the *Delay start* button.



- Touch the  $\nabla$  sensor.





- Touch the *OK* sensor. The wash programme will start.

# Programme chart

<b>Cottons</b>		<b>Cold to 90°C</b>	<b>Max. load 8.0 kg</b>
Items	Cottons, linens or cotton mix fabrics, e.g. table linen, towelling, underwear, T-shirts etc.		
Notes	Where particularly high levels of hygiene are required, please select a temperature of 90°C.		
<b>Cottons</b>		<b>60°C</b>	<b>Max. load 8.0 kg</b>
Items	Cottons, linens or cotton mix fabrics, e.g. table linen, towelling, underwear, T-shirts etc.		
Notes	With <b>60°C</b> the actual wash temperature reached will be lower than 60°C although the wash performance is the same as with the standard Cottons 60°C programme.		
<b>Cottons</b>		<b>40°C</b>	<b>Max. load 8.0 kg</b>
Items	Normally soiled cotton garments		
Notes	These settings are the most efficient in terms of energy and water consumption for washing cottons.		
Energy labelling programme according to AS/NZS 2040.1 & AS/NZS 2040.2			
<b>Minimum iron</b>		<b>Cold to 60°C</b>	<b>Max. load 4.0 kg</b>
Items	Synthetic, mixed fibre and easy care cotton.		
Note	Reduce the spin speed for fabrics which crease easily.		



## Programme chart

<b>Delicates</b>		<b>Cold to 60°C</b>	<b>Max. load 3.0 kg</b>
Items	Delicate garments made from synthetic fibre, mixed fibre, rayon and viscose. Curtains, including net curtains, specified as machine-washable by the manufacturer.		
Notes	<ul style="list-style-type: none"> <li>– Dust in curtains usually makes a programme with pre-wash advisable. Select the <i>Heavy</i> setting for the degree of soiling so that a pre-wash will be carried out.</li> <li>– For items which crease easily, deselect the spin.</li> </ul>		
<b>Woollens</b> 		<b>Cold to 40°C</b>	<b>Max. load 2.0 kg</b>
Items	Machine-washable or hand-washable wool or wool blend fabric. If the care label does not specify a temperature, wash using the cold setting.		
Note	Reduce the spin speed for items which crease easily.		
<b>Silks</b> 		<b>Cold to 30°C</b>	<b>Max. load 1.0 kg</b>
Items	Silks and other hand-washable fabrics with no wool content, e.g. satin, lace and silk.		
Note	Place tights, bras etc. in a washing bag.		
<b>Automatic plus</b>		<b>Cold to 40°C</b>	<b>Max. load 6.0 kg</b>
Items	Mixed loads of garments suitable for the <i>Cottons</i> and <i>Minimum iron</i> programmes. Sort according to colour.		
Note	The wash parameters (e.g. water level, wash rhythm and spin speed) are adjusted automatically in this programme to ensure the best possible care and wash result for each item.		

## Programme chart

<b>Down duvets</b>		<b>Cold to 60°C</b>	<b>Max. load 2.5 kg</b> <b>1 down duvet 2.20 m x 2.00 m</b>
Items	Quilts, duvets and pillows with feather or down filling.		
Notes	<ul style="list-style-type: none"> <li>– Remove air from the items before washing to prevent an excessive build-up of foam. To do this, either push the items into a narrow laundry bag to compress them or tie the items together with a washable strap.</li> <li>– Please observe the instructions on the wash care label.</li> </ul>		
<b>Outerwear</b>		<b>Cold to 40°C</b>	<b>Max. load 2.5 kg</b>
Items	Performance outerwear (e.g. jackets and trousers) made from membrane fabric such as Gore-Tex®, SYMPATEX®, WINDSTOPPER® etc.		
Notes	<ul style="list-style-type: none"> <li>– Zip up or close jackets before washing.</li> <li>– Do not use fabric softener.</li> <li>– If required, these garments can also be re-proofed using the <i>Proofing</i> programme. Proofing should not be done every time the garment is washed.</li> </ul>		
<b>Proofing</b>		<b>40°C</b>	<b>Max. load 2.5 kg</b>
Items	Treating microfibre fabric, skiwear and table linen made from mainly synthetic fibres to provide a water and dirt resistant finish.		
Notes	<ul style="list-style-type: none"> <li>– The items should be freshly laundered and spun or dried before proofing.</li> <li>– For best results, the items should be heat-treated afterwards either in a tumble dryer or by ironing.</li> </ul>		

## Programme chart

<b>Sportswear</b>		<b>Cold to 60°C</b>	<b>Max. load 3.0 kg</b>
Items	Sportswear such as singlets and leggings as well as microfibre and fleece garments.		
Notes	<ul style="list-style-type: none"> <li>– Do not use fabric softener.</li> <li>– Observe the manufacturer's care label.</li> </ul>		
<b>Separate rinse / Starch</b>		<b>Max. load 8.0 kg</b>	
Items	<ul style="list-style-type: none"> <li>– For rinsing hand-washed items.</li> <li>– Starching table cloths, serviettes and workwear.</li> </ul>		
Tip	<ul style="list-style-type: none"> <li>– Reduce the spin speed for items which crease easily.</li> <li>– Laundry that is to be starched should be washed but not treated with fabric softener.</li> <li>– Items will be rinsed very effectively using two rinse cycles by activating the <i>Water plus Extra</i> option.</li> </ul>		
<b>Clean machine</b>		<b>75°C</b>	<b>No load</b>
<p>With frequent washing at low temperatures there is a danger of a build-up of bacteria in the washing machine.</p> <p>Cleaning the washing machine will significantly reduce bacteria, fungus and biofilm and prevent the build-up of unpleasant odours.</p>			
Notes	<ul style="list-style-type: none"> <li>– Optimum results can be achieved by using Miele dishwasher and washing machine cleaner. Alternatively, a universal powder detergent can be used.</li> <li>– Dispense the machine cleaner or universal detergent directly in the drum.</li> <li>– Do not load any laundry. The drum must be empty for this machine maintenance wash.</li> </ul>		

## Programme chart

<b>QuickPowerWash</b>		<b>40°C – 60°C</b>	<b>Max. load 5.0 kg</b>
Items	Moderately soiled garments which are also suitable for washing in the <i>Cottons</i> programme.		
Note	– A special saturation process and wash rhythm ensure that the laundry is cleaned particularly quickly and thoroughly.		
<b>Express 20</b>		<b>Cold to 40°C</b>	<b>Max. load 3.5 kg</b>
Items	Cotton garments that have hardly been worn or are only very lightly soiled.		
Note	The <i>Short Extra</i> option is activated automatically.		
<b>Shirts</b>		<b>Cold to 60°C</b>	<b>Max. load 2.0 kg</b>
Items	Shirts and blouses made of cotton and mixed fibre.		
Notes	<ul style="list-style-type: none"> <li>– Pre-treat collars and cuffs if necessary.</li> <li>– Wash silk shirts and blouses in the <i>Silks</i>  programme.</li> </ul>		
<b>Darks / Denim</b>		<b>Cold to 60°C</b>	<b>Max. load 3.0 kg</b>
Items	Black and dark garments made from cotton, mixed fibres and denim.		
Notes	<ul style="list-style-type: none"> <li>– Wash inside out.</li> <li>– Denim often contains excess dye and may run during the first few washes. Wash light and dark coloured items separately.</li> </ul>		
<b>Drain/Spin</b>			<b>–</b>
Notes	<ul style="list-style-type: none"> <li>– Drain only: Select 0 rpm for the spin speed.</li> <li>– Make sure you select the appropriate spin speed.</li> </ul>		

Extra options are selected and deselected via the relevant buttons and the display.

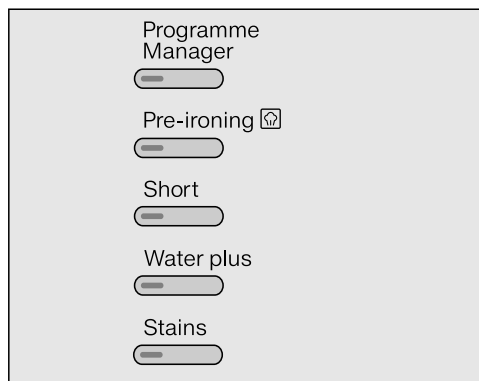

- Press the button for the Extra option you want.

The relevant button will light up.

Not all Extra options are suitable for use with every programme.

You can only select Extra options which are compatible with the programme being used.

### ProgrammeManager

The ProgrammeManager Extra option can be used to customise the washing programmes to suit your requirements.

#### Intensive

For hard-wearing laundry that is very heavily soiled. Cleaning efficiency is increased through more intense mechanical action and the application of more heat energy.

#### ECO

This option reduces energy consumption whilst maintaining cleaning efficiency. This is achieved by increasing the wash duration and at the same time reducing the wash temperature selected.





#### Extra gentle

This option decreases mechanical action in order to reduce creasing.

#### Extra quiet

This option reduces noise levels during the programme. Use this if you want to wash during quiet periods (for instance, when children are sleeping). The machine will activate the "Rinse hold" option and not spin. The programme duration is longer.

#### AllergoWash

This option should be used where high standards of hygiene are required. More energy is used to lengthen temperature holding times and more water is used to increase rinsing efficiency. The garments must be suitable for drying in a tumble dryer   and suitable for ironing  .





Not all ProgrammeManager options are suitable for use with every programme. Please refer to the "Wash programme chart - ProgrammeManager" for a list of suitable programmes.

## Extra options

---

### Pre-ironing

In order to reduce creasing, the laundry undergoes a smoothing process at the end of the programme. Reducing the maximum load by 50% will give a better result. Please note the load information in the display.

The garments must be suitable for drying in a tumble dryer   and suitable for ironing  .

### Short

For light soiling with no visible staining.

The wash duration is reduced.

### Water plus

The water level in the wash and rinse stages is increased and a second rinse is carried out in the "*Separate rinse / Starch*" programme.



You can select other functions for the *Water plus* button. These are described in "Settings".

### Stains

In order to clean stained laundry more effectively, you can choose between seven different types of stain. The wash programme will then adapt to the type of stain selected. You can select one stain per wash cycle.

## Wash programme chart - ProgrammeManager

ProgrammeManager cannot be selected with programmes which are **not** listed in the chart below.

	Intensive	ECO	Extra gentle	Extra quiet	Allergo Wash
Cottons	<b>X</b>	<b>X</b>	<b>X</b>	<b>X</b>	<b>X</b>
Minimum iron	<b>X</b>	<b>X</b>	<b>X</b>	<b>X</b>	<b>X</b>
Delicates	<b>X</b>	<b>X</b>	<b>X</b>	<b>X</b>	<b>X</b>
Woolens 	-	-	-	<b>X</b>	-
Silks 	-	-	-	<b>X</b>	-
Automatic plus	<b>X</b>	<b>X</b>	<b>X</b>	<b>X</b>	<b>X</b>
Down duvets	<b>X</b>	<b>X</b>	<b>X</b>	-	<b>X</b>
Outerwear	<b>X</b>	<b>X</b>	<b>X</b>	<b>X</b>	<b>X</b>
Proofing	-	-	-	<b>X</b>	-
Sportswear	<b>X</b>	<b>X</b>	<b>X</b>	<b>X</b>	<b>X</b>
Separate rinse / Starch	-	-	-	<b>X</b>	-
Express 20	-	-	-	<b>X</b>	-
Shirts	<b>X</b>	<b>X</b>	<b>X</b>	<b>X</b>	<b>X</b>
Darks / Denim	<b>X</b>	<b>X</b>	<b>X</b>	<b>X</b>	<b>X</b>

**X** = Can be selected

- = Cannot be selected

## Extra options

The following Extra options can be selected in addition to the programme:

None of the Extra options can be selected with programmes which are **not** listed in the chart below.

	Pre-wash <sup>1)</sup>	Pre-ironing 	Short	Water plus	Stains
Cottons	X	X	X	X	X
Minimum iron	X	X	X	X	X
Delicates	X	X	X	X	X
Automatic plus	X	X	-	-	X
Down duvets	X	-	-	X	-
Outerwear	X	-	X	X	X
Sportswear	X	-	X	X	X
Separate rinse / Starch	-	-	-	X	-
QuickPowerWash	-	X	-	-	-
Express 20	-	X	X <sup>2)</sup>	-	-
Shirts	X	X <sup>2)</sup>	X	X	X
Darks / Denim	X	X	X	X	X

**X** = Can be selected

- = Cannot be selected

1) = Activated automatically when the Heavy degree of soiling setting is selected

2) = Can be deselected



# Garment care label symbols

Washing	
The figure quoted in the bucket is the maximum temperature at which the garment can be washed. The number of bars under the symbol indicates the level of agitation permitted.	
	No bar under the symbol = normal agitation
	One bar under the symbol = reduced agitation
	Two bars under the symbol = much reduced agitation
	Hand wash (If no temperature is specified, use the lowest temperature or cold)
	Do not wash

## Programme selection examples

Programme	Garment care label symbols
Cottons	
Minimum iron	
Delicates	
Woollens	
Silks	
Express 20	
Automatic plus	

Drying	
The number of dots indicates the drying temperature.	
	Normal temperature
	Low temperature
	Do not tumble dry

Ironing	
The number of dots indicates the ironing temperature.	
	approx. 200°C
	approx. 150°C
	approx. 110°C
	Do not steam iron garments carrying this symbol as this could cause irreversible damage.
	Do not iron



Professional cleaning	
	Dry clean only. The letters indicate the type of cleaning agent required.
	Professional Wet Clean only
	Do not dry clean

Bleaching	
	Any oxidising bleaching agent can be used
	Only use an oxygen based bleach or a non-chlorine bleach
	Do not bleach

# Programme sequence

	Main wash		Rinse		Spin
	Water level	Wash rhythm	Water level	Rinses	
Cottons		(A)		2-5 <sup>1)2)3)</sup>	✓
Minimum iron		(B)		2-4 <sup>2)3)</sup>	✓
Delicates		(C)		2-4 <sup>2)3)</sup>	✓
Woolens 		(E)		2	✓
Silks 		(E)		2	✓
Automatic plus		(A)(B)		2-4 <sup>2)3)</sup>	✓
Down duvets <sup>4)</sup>		(C)		3-4 <sup>3)</sup>	✓
Outerwear		(C)		3-4 <sup>3)</sup>	✓
Proofing	–	(B)		1	✓
Sportswear		(C)		2-3 <sup>3)</sup>	✓
Separate rinse / Starch		(B)		0-1 <sup>5)</sup>	✓
Clean machine		(A)		3	✓
QuickPowerWash		(A)		1	✓
Express 20		(A)		1	✓
Shirts		(C)		3-4 <sup>3)</sup>	✓
Darks / Denim		(B)		3-5 <sup>2)3)</sup>	✓
Drain/Spin	–	–	–	–	✓

Please see the next page for a description of the symbols.

-  = Low water level  
 = Medium water level  
 = High water level  
Ⓐ = Intensive rhythm  
Ⓑ = Normal rhythm  
Ⓒ = Sensitive rhythm  
Ⓓ = Ultra sensitive rhythm  
Ⓔ = Handwash rhythm  
✓ = Carried out  
– = Not carried out

The washing machine has fully electronic controls with automatic load recognition. It takes in the right amount of water required for the programme depending on the amount of laundry and its absorbency rate.

The programme sequences outlined in the chart are based on the basic programme with a full load.

The washing machine programme sequence display shows which stage of the programme has been reached.

## Special features in the programme sequence

### Anti-crease:

At the end of the programme the drum continues to turn at intervals for up to 30 minutes to help prevent creasing.

Exception: There is no Anti-crease phase in the *Woollens* programme.

The door can be opened at any time during the Anti-crease phase.

- 1) A second rinse is carried out when a temperature of  $\leq 60^{\circ}\text{C}$  or above is selected. A third rinse is carried out when a temperature below  $\leq 60^{\circ}\text{C}$  is selected.
- 2) An additional rinse is carried out if:
  - there is too much foam in the drum.
  - a spin speed lower than 700 rpm has been selected.
  - the spin speed has been deselected.
- 3) An additional rinse is carried out if:
  - the *Water plus Extra* option is selected and the Extra rinse or Extra water + rinse setting has been activated for the *Water plus Extra* option in *Settings*.
- 4) Run-up to spin: A run-up to spin is carried out before the wash process begins to deflate down filled items. Subsequent water intake for the main wash is through compartment  $\text{U1}$ .
- 5) An additional rinse is carried out if: the *Water plus Extra* option is selected.

## Changing the programme sequence

---

### Cancelling a programme

You can cancel a programme at any time after it has started.

- Press the *Start/Stop* button.

The following will appear in the display:



Cancel programme

- Touch the *OK* sensor.

The suds will be pumped away. The following will appear in the display:



Prog. cancelled

- Pull open the door.
- Remove the laundry.

### If you want to select a different programme:

- Close the door.
- Select the programme you want.
- Add detergent to the detergent dispenser drawer, if necessary.
- Press the *Start/Stop* button.

The new programme will begin.

### Interrupting a programme

- Switch the washing machine off with the ① button.
- Switch the washing machine back on with the ① button to continue with the same programme.

### Changing a programme and settings

#### Programme

After the start of a programme, it is no longer possible to select a different programme.

#### Temperature

The temperature can be changed within the first five minutes, except in the *Cottons* programme.

- Press the *Temperature* button.
- Use the  $\vee$ ,  $\wedge$  and *OK* sensors to change the temperature.

#### Spin speed

Once a programme has started, you can change the spin speed up until the final spin begins.

- Press the *Spin speed* button.
- Use the  $\vee$ ,  $\wedge$  and *OK* sensors to change the spin speed.

#### Extra options

It is possible to select or deselect the *Short* and *Water plus* Extra options up to five minutes after the programme has started.

**Useful tip:** It is not possible to make any changes to the programme or to cancel it if the safety lock has been activated.

# Changing the programme sequence

## Adding or removing laundry after a programme has started

- Press the *Start/Stop* button.

The following will appear in the display:

Cancel programme



- Scroll up the list with the  $\nabla$  or  $\blacktriangle$  sensor to:

Add laundry



- Touch the *OK* sensor.

If this message does not appear in the display, then it is no longer possible to add or remove items of laundry.

The programme will stop and the door will unlock.

- Pull open the door.
- Add or remove items.
- Close the door.
- Press the *Start/Stop* button.

The programme will continue.

Please note the following:

Once a programme has started, the washing machine cannot recognise any adjustment to the load.

For this reason, if laundry is added or removed after the start of a programme, the machine will always complete the programme cycle assuming a full load.

### The door cannot be opened if:

- the suds temperature is above **55°C**.
- the water is above a certain level.
- the programme has reached the *Spin* stage.

If you want to open the door when the above conditions are present, you will need to cancel the programme.

The safety lock will remain activated if the temperature in the drum is above 55°C. The lock will not deactivate until the temperature has dropped to below 55°C.

## Changing the programme sequence

---

### Safety lock

The safety lock prevents the temperature, spin speed or options being altered during a wash programme.

#### Activating the safety lock

- Press the *Start/Stop* button.

The following will appear in the display:

Cancel programme



- Scroll up the list with the  $\nabla$  or  $\blacktriangle$  sensor to:

Activate safety lock



- Touch the *OK* sensor.

### Deactivating the safety lock

- Proceed as for activating the safety lock.

The following appears in the display:

Deactiv. safety lock



- Touch the *OK* sensor.

The safety lock is now deactivated.

## The correct detergent

All detergents produced for automatic front loading washing machines are suitable. Follow the manufacturer's instructions and dosage recommendations on the packaging.

## The right amount to dispense will depend on the following:

- The soiling level of the laundry.
- The quantity of laundry.

## Detergent dispensing aids

Use dispensing aids, (e.g. balls) if these are supplied with the detergent, particularly when using liquid detergent.

## Refill packs of detergent

When purchasing detergent, buy refill packs wherever possible. This helps reduce the amount of waste packaging.

## Fabric softeners and liquid starch

### Fabric softeners

make garments soft to handle and help prevent static cling when tumble drying.

### Fabric shapers

are synthetic starches and give an even stiffer hold.





### Starch

stiffens and gives body to items of laundry, e.g. shirts, tablecloths and bed linen.

# Detergent

## Miele recommended detergents

Miele detergents and care products have been specially designed for Miele washing machines. They are available to order via the internet at [www.miele-shop.com](http://www.miele-shop.com) (depending on country) or from Miele.

	Miele UltraPhase 1 / 2	Miele Cap 	Miele Cap 	Miele Cap 
Cottons	✓	–	Ⓔ	Ⓕ
Minimum iron	✓	–	Ⓔ	Ⓕ
Delicates	✓	Ⓐ, Ⓑ	Ⓔ	–
Woolens 	–	Ⓒ, Ⓓ	–	–
Silks 	–	Ⓓ	–	–
Automatic plus	✓	–	Ⓔ	Ⓕ
Down duvets	–	Ⓑ	–	–
Outerwear	–	–	–	–
Proofing	–	–	–	–
Sportswear	–	Ⓐ	–	–
Separate rinse / Starch	–/–	–/–	Ⓔ/–	–/–
QuickPowerWash	✓	–	–	–
Express 20	✓	–	Ⓔ	–
Shirts	✓	–	Ⓔ	Ⓕ
Darks / Denim	✓	–	Ⓔ	–

✓ Recommended

– Not recommended

Ⓐ Sportswear

Ⓑ Down Items

Ⓒ WoolCare

Ⓓ SilkCare



Ⓔ Fabric Softener

Ⓕ Booster



# Detergent

The recommendations apply to the temperature ranges given in the Programme chart.

	Universal	Colour	Delicates and woollens	Special
	detergent			
Cottons	✓	✓	-	-
Minimum iron	-	✓	-	-
Delicates	-	-	✓	-
Woollens 	-	-	✓	✓
Silks 	-	-	✓	✓
Automatic plus	-	✓	-	-
Down duvets	-	-	✓	✓
Outerwear	-	-	✓	✓
Sportswear	-	-	✓	✓
Clean machine	✓ <sup>2)</sup>	-	-	✓
QuickPowerWash	✓	✓	-	-
Express 20	-	✓ <sup>1)</sup>	-	-
Shirts	✓	✓	-	-
Dark garments/Denim	-	✓ <sup>1)</sup>	-	✓

✓ Recommended

- Not recommended

1) Liquid detergent

2) Powder detergent

# Detergent

## Dispensing fabric softener and liquid starch at the end of the programme

You can dispense fabric softener either by using automatic dispensing or via the detergent dispenser compartment.

### Automatic dispensing

One of the automatic dispensing containers must be filled with fabric softener.

- Touch the *Dos*  sensor.
- Activate the appropriate container.

Fabric softener will be dispensed in the last rinse.

## Manual dispensing

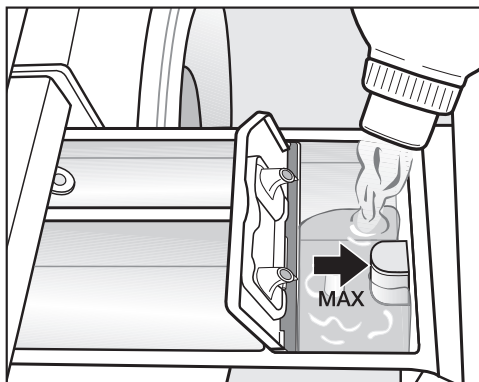

- Add the fabric softener or liquid starch to the  compartment or insert the appropriate capsule. **Do not exceed the maximum level mark.**

It will be automatically dispensed in the final rinse. At the end of the programme a small amount of water will remain in the  compartment.

If starching frequently, thoroughly clean the dispenser compartment, especially the siphon tube, regularly.

## Colour run and dye removers/dyes





 **Do not use** colour run or dye removers in this washing machine. They can cause corrosion in the machine.

Dyes suitable for use in domestic washing machines can be used. However, please note that the salt used in the dyeing process can cause corrosion to stainless steel components in the machine if you dye frequently. Always observe the manufacturer's instructions carefully.

## Adding fabric softener or liquid starch separately

Prepare the starch in accordance with the manufacturer's instructions on the packaging.

**Useful tip:** When adding fabric softener separately, activate the *Water plus Extra* option.

- Add fabric softener to the  compartment or insert the appropriate capsule.
- Add liquid starch to the  compartment and powder or viscous starch to the  compartment.
- Select the *Separate rinse / Starch* programme.
- Change the spin speed if necessary.
- Activate the *Cap*  sensor if using a capsule.
- Press the *Start/Stop* button.

## Cleaning and care

### Cleaning the drum (Hygiene info)

Washing at low temperatures and/or using liquid detergent can cause bacteria and unpleasant odours to build up in the washing machine. Use the *Clean machine* programme to clean the machine. Run this programme regularly or at the latest when the Hygiene info message appears in the display.

### External casing and fascia panel

⚠ Disconnect the machine from the mains electricity supply and withdraw the plug from the socket before cleaning the machine.

⚠ The washing machine must not be hosed down.

- Clean the casing with a mild non-abrasive cleaning agent or soap and water using a well wrung-out cloth. Wipe dry with a soft cloth.
- The drum can be cleaned using a suitable proprietary stainless steel cleaning agent following the manufacturer's instructions on the packaging.

⚠ Do not use solvents, abrasive cleaners, glass cleaners or all-purpose cleaning agents. These might damage plastic surfaces and other components because of the chemicals they contain.

### Cleaning the detergent dispenser drawer

Washing at low temperatures and the use of liquid detergent can lead to a build-up of mould and bacteria in the detergent dispenser drawer.

- Clean the entire drawer at regular intervals for hygiene reasons, even if you are using the TwinDos system exclusively.

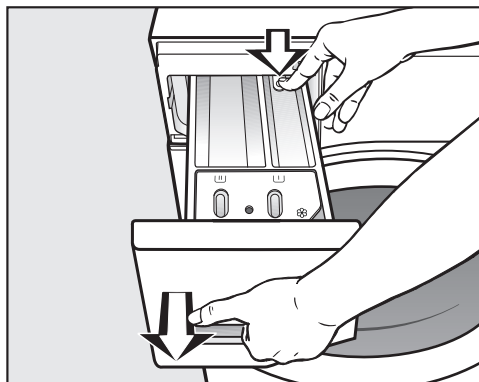

- Pull out the detergent dispenser drawer until a resistance is felt. Press down the release button and at the same time pull the drawer right out of the machine.
- Clean the detergent drawer with warm water.

## Cleaning the siphon tube and the fabric softener channel

Liquid starch can cause the siphon to become clogged. Make sure that you clean the siphon and siphon tube particularly thoroughly after using liquid starch a few times.

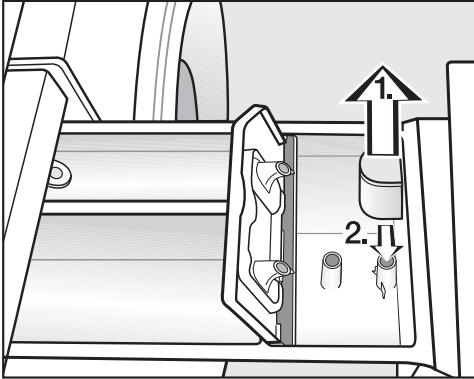

### ■ Clean the siphon.

1. Remove the siphon from compartment  and rinse under warm running water. Clean the siphon tube in the same way.
2. Refit the siphon.

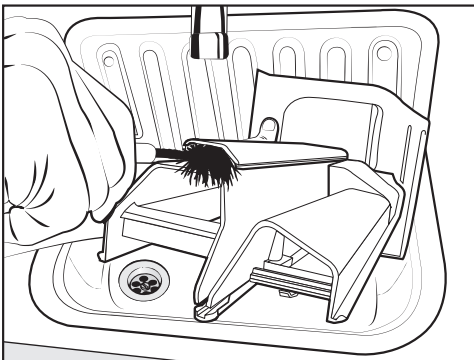

- Clean the fabric softener channel using a brush and warm water.

## Cleaning the detergent dispenser drawer housing

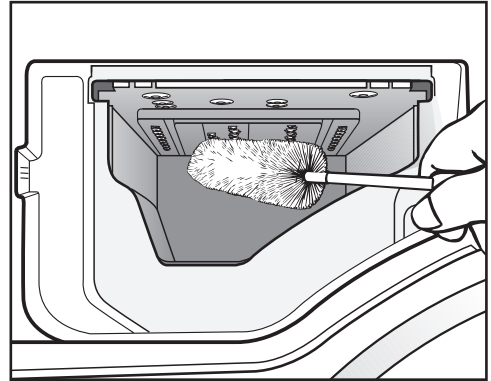

- Use a bottle brush to remove detergent residues and limescale from the jets inside the detergent dispenser drawer housing.
- Replace the detergent dispenser drawer.

**Useful tip:** Leave the detergent dispenser drawer slightly open to allow it to dry.

# Cleaning and care

## Cleaning the TwinDos system

 If the system has not been used for a long time (more than two months), the detergent in the hoses can become viscous.

The hoses could become blocked and would then need to be cleaned by a service technician.

Clean the TwinDos system every time you change brand of liquid detergent or fabric softener or if the system has not been used for a long period of time.

The washing machine has a cleaning programme for cleaning the TwinDos system and the hoses inside the washing machine.

The TwinDos containers (optional accessory) are required to carry out cleaning. These are available to order from Miele or via the internet at [www.miele-shop.com](http://www.miele-shop.com) (see end of this booklet for details).

- Switch on the washing machine and wait until the standard display lights up.
- Touch the ∨ and ∧ sensors at the same time until the following appears in the display:

Language 

The Settings menu is activated.

- Touch the ∨ sensor until the following appears in the display:

Dispensing unit

- Confirm the setting with the *OK* sensor.
- Touch the ∨ sensor until the following appears in the display:

Maintenance 

- Confirm the setting with the *OK* sensor.

Compartment 1

- Touch the ∨ or ∧ sensor until the container (or containers) you want appears in the display and confirm this with the *OK* sensor.
- Follow the instructions in the display.

After cleaning you can fill one or both containers with new liquid detergent and/or fabric softener.

## Cleaning the compartment

Detergent residue can cause clogging.

- Use a damp cloth to clean the compartment interior when you change the cartridge or container.

### Cleaning the water inlet filter

The washing machine has a filter to protect the water inlet valve. This filter should be checked every six months or so, or more often if there are frequent interruptions to the water supply.

- First turn off the tap.
- Unscrew the inlet hose from the tap.

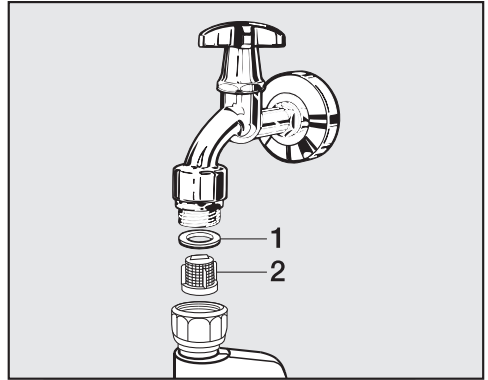

- Remove the rubber seal **1** from the recess.
- Using pointed pliers, take hold of the plastic filter bar **2** and remove.
- Put the filter and seal back in the reverse order and reconnect the hose.

Turn on the tap and check the connection is watertight. If water drips out, tighten the connection.

**Never** forget to put the filter back in place after cleaning.

# Problem solving guide

## Problem solving guide



With the help of the following guide, minor faults in the performance of the appliance, some of which may result from incorrect operation, can be put right without contacting Miele. This will save time and money.

Please note that a call-out charge will be applied to unnecessary service visits where the problem could have been rectified as described in these operating instructions.

 Repair work to electrical appliances should only be carried out by an authorised Miele service technician. Repairs and other work by unqualified persons could be dangerous. Miele cannot be held liable for unauthorised work.









Some of the messages in the display are more than one line long. Touch the  $\vee$  or  $\wedge$  sensor to read them in full.

## The programme does not start

Problem	Possible cause and remedy
<b>The display remains dark, and the Start/Stop button indicator light does not come on.</b>	There is no power to the machine. <ul style="list-style-type: none"><li>■ Check whether the mains plug is plugged in and switched on.</li><li>■ Check whether the fuse or circuit breaker has tripped.</li></ul>
	The washing machine has switched off automatically to save energy. <ul style="list-style-type: none"><li>■ Switch it back on with the  button.</li></ul>
<b>You are asked to enter a code.</b>	Access via a code has been activated. <ul style="list-style-type: none"><li>■ Enter the code and confirm the entry. Deactivate the code if you do not wish this message to appear in the display the next time the machine is switched on.</li></ul>
<b>The following appears in the display:</b>  Call service  Door locked	The door is not closed properly. The door lock could not engage. <ul style="list-style-type: none"><li>■ Close the door again.</li><li>■ Start the programme again.</li></ul> If the fault message appears again, contact Miele.



The following fault message appears in the display and the programme has been cancelled

Problem	Possible cause and remedy
 Check inlet See 	<p>The water inlet is blocked or restricted.</p> <ul style="list-style-type: none"> <li>■ Check whether the tap is turned on properly.</li> <li>■ Check whether the inlet hose is kinked.</li> <li>■ Check whether there is sufficient water pressure.</li> </ul> <p>The filter in the water inlet is blocked.</p> <ul style="list-style-type: none"> <li>■ Clean the filter.</li> </ul>
 Check drain See 	<p>The water outlet is blocked or restricted. The drain hose has been fixed too high.</p> <ul style="list-style-type: none"> <li>■ Clean the filters and the drain pump.</li> <li>■ The maximum drain height is 1 m.</li> </ul>
 Call service  Waterproof syst.	<p>The water protection system has reacted.</p> <ul style="list-style-type: none"> <li>■ Turn off the tap.</li> <li>■ Call Miele.</li> </ul>
 Call service  Fault F	<p>There is a fault.</p> <ul style="list-style-type: none"> <li>■ Start the programme again. If the fault message appears again, contact Miele.</li> </ul>

To switch off the fault messages: Switch the washing machine off with the  button.

## Problem solving guide

---

The following fault message appears in the display at the end of a programme

Problem	Possible cause and remedy
<b>i</b> Check recirc. pump	<p>The pumps are dirty.</p> <ul style="list-style-type: none"><li>■ Clean the pumps as described in "Problem solving guide - Opening the door in the event of a blocked drain outlet and/or power failure".</li><li>■ Start the programme again after cleaning the pumps.</li></ul> <p>The jet in the top of the door ring is blocked with fluff.</p> <ul style="list-style-type: none"><li>■ Remove the fluff with your finger. Do not use any sharp or pointed tools to do this.</li><li>■ Start the programme again after cleaning the jet.</li></ul> <p>If the fault message appears again, contact Miele. The washing machine can still be used but with reduced functionality.</p>
<b>i</b> Align the washing machine	<p>The smoothing process which the laundry undergoes at the end of the programme could not be carried out properly.</p> <ul style="list-style-type: none"><li>■ Check whether the washing machine is aligned correctly as described in "Installation and connection - Levelling the machine".</li><li>■ Check whether the maximum delivery height of 1 m has been exceeded.</li></ul> <p>If the fault message appears again, contact Miele. The washing machine can still be used but with reduced functionality.</p>

The messages will appear at the end of the programme and when the washing machine is switched on and need to be confirmed with the OK sensor.

The following fault message appears in the display at the end of a programme

Problem	Possible cause and remedy
<b>i</b> Check detergent	Excessive foam has built up during washing. <ul style="list-style-type: none"> <li>■ Check the amount of detergent dispensed.</li> <li>■ With automatic detergent dispensing, check the dosage amount set.</li> <li>■ Observe the instructions on the detergent packaging and the degree of soiling of the laundry.</li> <li>■ If necessary, reduce the dosage amount by increments of 10%.</li> </ul>
<b>i</b> Hygiene info	A programme of at least 60°C has not been run for a long period of time. <ul style="list-style-type: none"> <li>■ In order to prevent bacteria and unpleasant odours building up in the machine, run the <i>Clean machine</i> programme using Miele dishwasher and washing machine cleaner or powder detergent.</li> </ul>
<b>i</b> Container 1 empty <b>or</b> Container 2 empty <b>or</b> Cont. 1 + 2 empty	The TwinDos container (or containers) is empty. <ul style="list-style-type: none"> <li>■ Fill the container or containers with liquid detergent or fabric softener or replace the cartridge(s).</li> <li>■ Check if the laundry is clean. There may not have been enough detergent used. If necessary, wash the items again.</li> </ul>

The messages will appear at the end of the programme and when the washing machine is switched on and need to be confirmed with the OK sensor.

# Problem solving guide

---

## Problems with TwinDos

Problem	Possible cause and remedy
<b>No detergent and/or fabric softener was dispensed.</b>	Automatic dispensing has not been activated. ■ Touch the <i>Dos</i>  sensor before running the next programme. Automatic dispensing will be activated.
	No detergent/fabric softener was dispensed although automatic dispensing was activated. ■ Try again. ■ If detergent is still not dispensed, call Miele.
<b>There are dark specks in the liquid detergent.</b>	Mould has developed in the detergent. ■ Pour the liquid detergent out of the container and then clean the container thoroughly.



## General problems with the washing machine

Problem	Possible cause and remedy
<b>The machine shakes during the spin cycle.</b>	The machine feet are not level. <ul style="list-style-type: none"> <li>■ Level the machine and adjust the feet correctly.</li> </ul>
<b>The laundry has not been spun properly and the laundry is still wet.</b>	The machine detected an imbalance during the final spin and reduced the spin speed automatically. <ul style="list-style-type: none"> <li>■ Include both large and small items in the load as this will give better distribution.</li> </ul>
<b>The pump makes strange noises.</b>	This is not a fault. These slurping noises occur at the end of the pump sequence as a normal part of operation.
<b>Large amounts of detergent residue remain in the detergent dispenser drawer.</b>	The water pressure is too low. <ul style="list-style-type: none"> <li>■ Clean the filter in the water inlet.</li> <li>■ It may be useful to select the <i>Water plus Extra</i> option.</li> </ul>
	Powder detergent used with water softeners can become sticky. <ul style="list-style-type: none"> <li>■ Clean the detergent dispenser drawer and in future add washing powder and then add the water softener.</li> </ul>
<b>Fabric softener is not completely dispensed or too much water remains in the  compartment.</b>	The siphon tube is not correctly positioned, or is clogged up. <ul style="list-style-type: none"> <li>■ Clean the siphon (see "Cleaning and care - Cleaning the detergent dispenser drawer").</li> </ul>
<b>The display is dark.</b>	The display has switched off automatically to save energy (Standby mode). <ul style="list-style-type: none"> <li>■ Press any button. Standby comes to an end.</li> </ul>

# Problem solving guide

---

## General problems with the washing machine



Problem	Possible cause and remedy
<b>At the end of the programme there is still liquid in the capsule.</b>	The small pipe in the detergent dispenser drawer onto which the capsule is placed is blocked. ■ Clean the small pipe.
	This is not a fault. For technical reasons, a small amount of water will remain in the capsule.
<b>There is water next to the capsule in the fabric softener compartment.</b>	The <i>Cap</i>  sensor was not activated or an empty capsule was not removed at the end of the last programme. ■ Make sure that you remember to activate the <i>Cap</i>  sensor the next time you insert a capsule. ■ Remove and then dispose of the empty capsule at the end of each programme.
	The small pipe in the detergent dispenser drawer onto which the capsule is placed is blocked. ■ Clean the small pipe.
<b>The display is in a different language.</b>	A different language has been selected in "Settings / Language  ". ■ Set the language you want. The flag symbol will guide you.

## An unsatisfactory wash result

Problem	Possible cause and remedy
<b>Liquid detergent does not give the required result.</b>	<p>Liquid detergents usually contain no bleaching agents. They do not remove fruit, coffee and tea stains.</p> <ul style="list-style-type: none"><li>■ Use the Miele 2 Phase System. The targeted addition of UltraPhase 2 during the wash process removes stains effectively.</li><li>■ Use a general purpose powder detergent containing a bleaching agent.</li></ul>
<b>Grey, greasy particles cling to washed laundry.</b>	<p>Insufficient amounts of detergent were used to break down the particles of grease in heavily soiled laundry.</p> <ul style="list-style-type: none"><li>■ Use more detergent or liquid detergent.</li><li>■ Before washing the next load, run the <i>Clean machine</i> programme using Miele dishwasher and washing machine cleaner or a powder detergent.</li></ul>
<b>White residues which look like powder detergent are seen on dark textiles after washing.</b>	<p>The detergent contained compounds (zeolites) to aid water softening which are not soluble in water. These have ended up on the laundry.</p> <ul style="list-style-type: none"><li>■ Try and brush off the residues with a soft brush once the laundry is dry.</li><li>■ Wash dark textiles using a detergent which does not contain zeolites. Liquid detergents usually do not contain zeolites.</li><li>■ Use the <i>Dark garments/Denim</i> programme.</li></ul>

# Problem solving guide

## The door will not open

Problem	Possible cause and remedy
<b>The door cannot be pulled open during a programme.</b>	The drum is locked during a programme. <ul style="list-style-type: none"><li>■ Press the <i>Start/Stop</i> button.</li><li>■ Use the √ sensor to select <i>Cancel programme</i> or <i>Add laundry</i>.</li></ul> The door will unlock and you will be able to pull it open.
	There is still water in the drum and the machine is unable to drain. <ul style="list-style-type: none"><li>■ Clean the drain filter and the drain pump as described in "Opening the door in the event of a blocked drain outlet and/or power failure".</li></ul>
	The water level in the drum is too high. <ul style="list-style-type: none"><li>■ Cancel the programme. The water will be pumped away.</li></ul>
Extra cooling <b>appears in the display after a programme has been cancelled.</b>	For safety reasons, the door cannot be opened if the suds temperature is higher than 55°C. <ul style="list-style-type: none"><li>■ Wait until the temperature in the drum has decreased and the message has gone out in the display.</li></ul>
<b>The following appears in the display:</b>  Call service  Door jammed	The door lock has jammed. <ul style="list-style-type: none"><li>■ Call Miele.</li></ul>



## Opening the door in the event of a blocked drain outlet and/or power cut

- Switch off the washing machine.

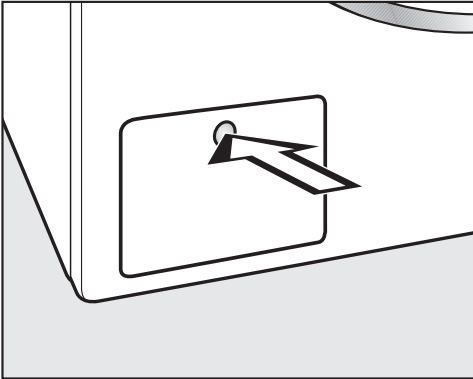

- Press the drain pump access panel.

The panel will spring open.

## Blocked drain outlet

If the drain outlet is blocked, a large quantity of water (up to 25 litres) can remain in the washing machine.

 **Caution:** If laundry has been washed at a high temperature, water draining out of the machine will still be hot. Danger of scalding!

## Procedure for draining the washing machine

When draining water from the machine, do not unscrew the filters completely or take them right out.

- Place a suitable container, e.g. a Miele universal oven tray, under the access panel.

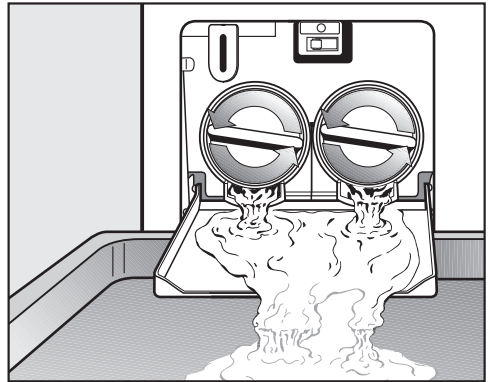

- Slowly and carefully unscrew the filters to let the water out. Be careful not to release too much water at once. If the flow of water is too strong, some water can seep into the washing machine base and activate the water protection float switch. This will prevent the washing machine from functioning.
- Tighten the filters back up again if you need to interrupt the flow of water.

Once the flow of water ceases:

## Problem solving guide

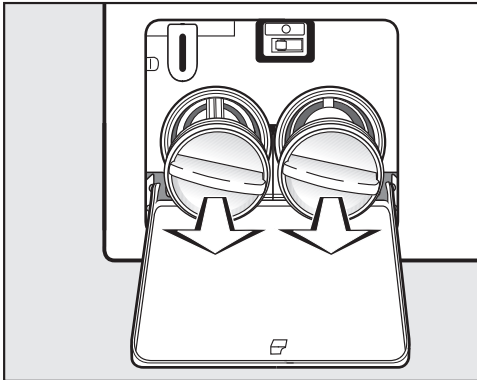

- Remove the filters completely.

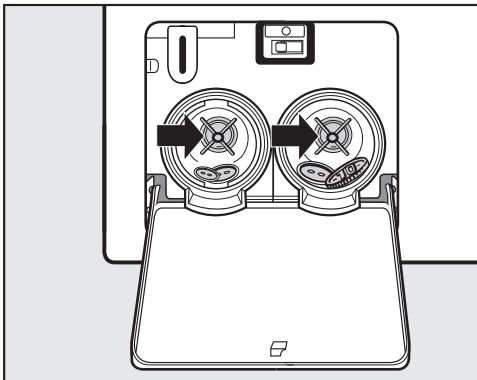

- Clean them thoroughly.
- Remove any foreign objects (e.g. buttons, coins, etc.) and fluff from the filter housing. Turn the impellers by hand to check that they rotate freely.

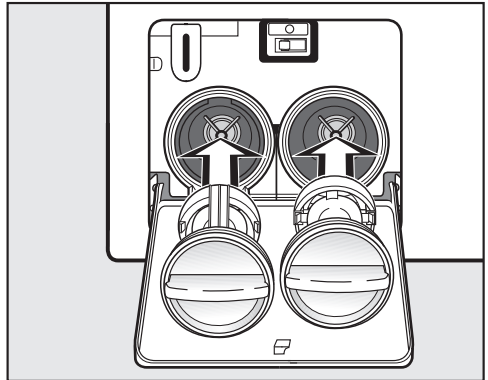

- Replace the filters correctly (on the right and left) and tighten them securely.

⚠ Make sure the filters are securely tightened. Otherwise there is a risk of water leakage during use.

### Opening the door

⚠ Always make sure that the drum is stationary before reaching in to remove laundry. Reaching into a moving drum is extremely dangerous.

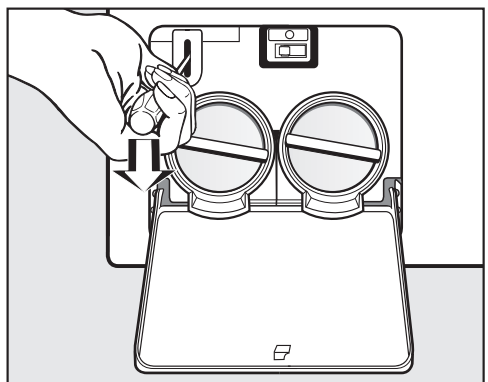

- Use a screwdriver to unlock the door.
- Pull open the door.

### Repairs

In the event of any faults which you cannot remedy yourself, please contact Miele.

The contact details for Miele are given at the back of these instructions.

When contacting Miele, please quote the model and serial number of your machine, both of which are visible on the data plate above the porthole glass when the door is open.

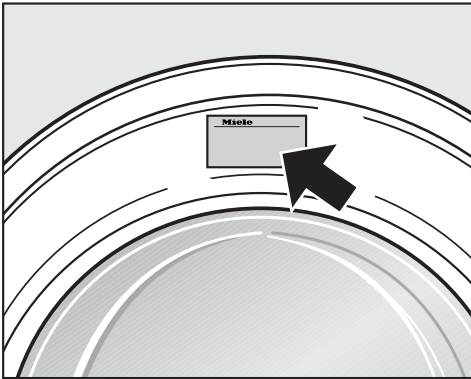

### Optional accessories

Optional spare parts and accessories for this washing machine are available from Miele.

### Warranty

The manufacturer's warranty for this appliance is 2 years.

See the warranty card supplied with the washing machine for further details.

# Installation and connection

## Front view

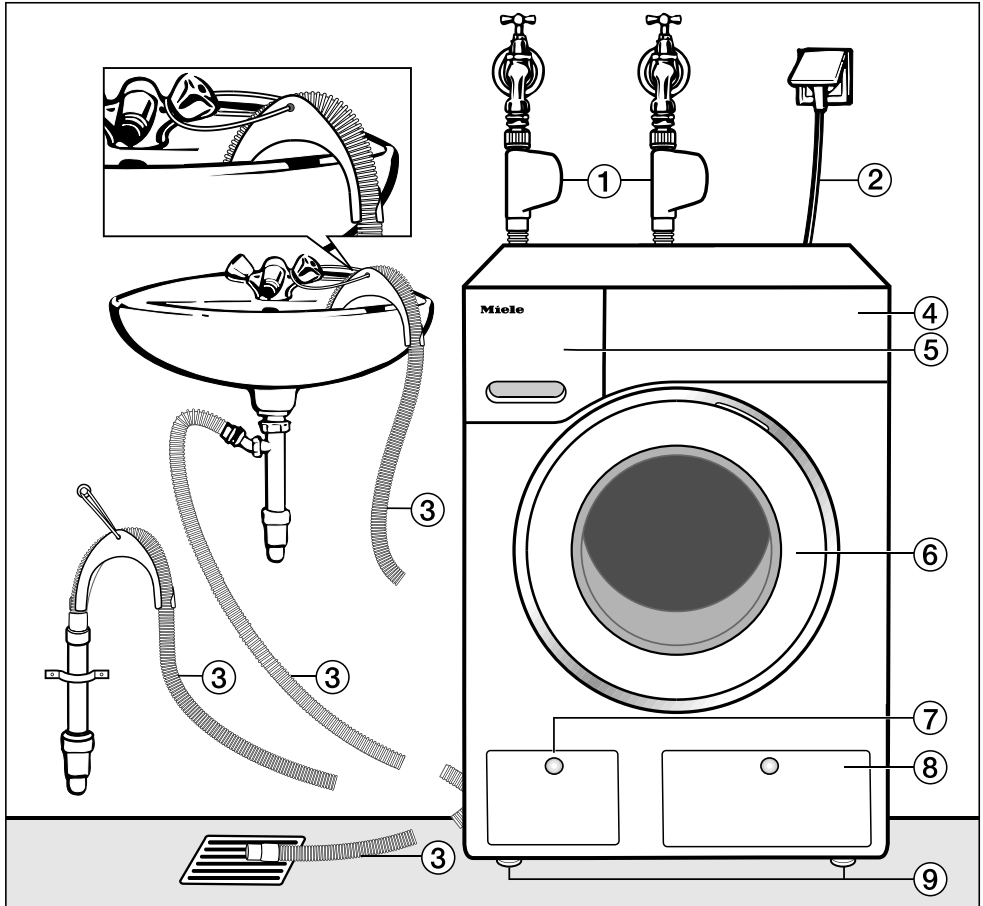

① Inlet hoses with water protection system for cold water and hot water connection

② Electrical connection

③ Flexible drain hose (with detachable swivel elbow)

④ Control panel

⑤ Detergent dispenser drawer

⑥ Door

⑦ Access to filters, pumps and emergency release

⑧ Access panel for TwinDos containers

⑨ Four height adjustable feet

## Rear view

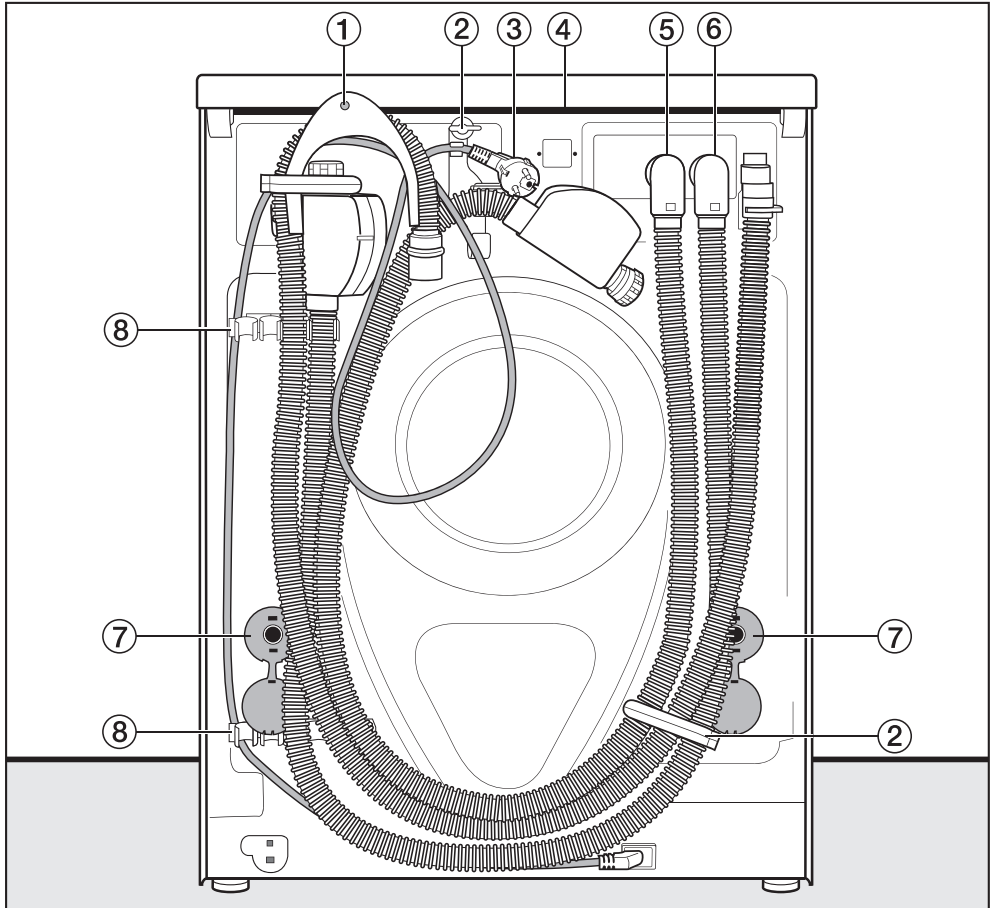

- ① Drain hose
- ② Transport clips for electrical connection cable, inlet and drain hoses
- ③ Electrical connection
- ④ Protruding lid for holding when moving the machine
- ⑤ Inlet hose with water protection system for cold mains water
- ⑥ Inlet hose with water protection system for hot water
- ⑦ Safety caps for transit bars
- ⑧ Transport clips for inlet and drain hoses and for storing transit bars when not in use

# Installation and connection

## Installation surface

A concrete floor is the most suitable installation surface for a washing machine, being far less prone to vibration during the spin cycle than wooden floorboards or a carpeted surface.

Please note:

- The machine must be level and securely positioned.
- To avoid vibrations during spinning, the machine should not be installed on soft floor coverings.

If installing on a wooden joist floor:

- We recommend a plywood base (at least 59 x 52 x 3 cm). The base should span several joists and be bolted to the joists and not only to the floorboards. Check for the presence of pipes and cables first.

**Useful tip:** If possible, install the machine in a corner, as this is usually the most stable part of the floor.

## Transporting the washing machine to its installation site

To manoeuvre the washing machine out of its packing case to its installation site, hold it by the front feet as well as by the edge of the lid where it protrudes to the rear of the machine.

 Ensure that the machine feet and the floor are dry to prevent the machine from slipping during the spin cycle.

## Removing the transit bars

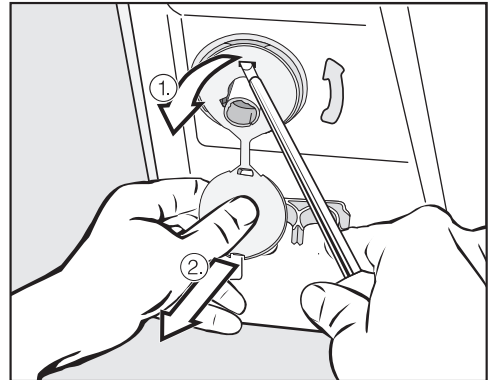

- Remove the left and right covers.
  1. Pull off the transit bar covers and
  2. then use a screwdriver to release the catches at the top and bottom.

## Installation and connection

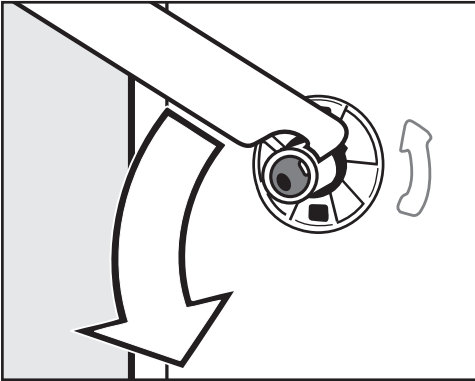

- Using the spanner supplied, turn the left-hand transit bar 90°, then

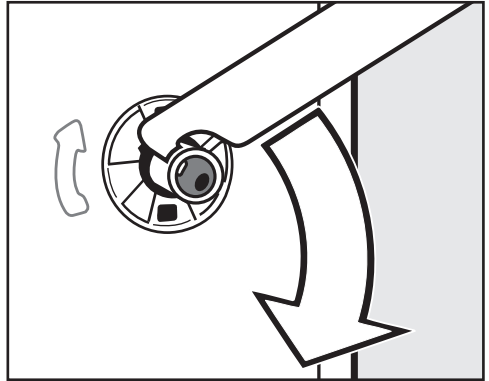

- Turn the right-hand transit bar 90°, then

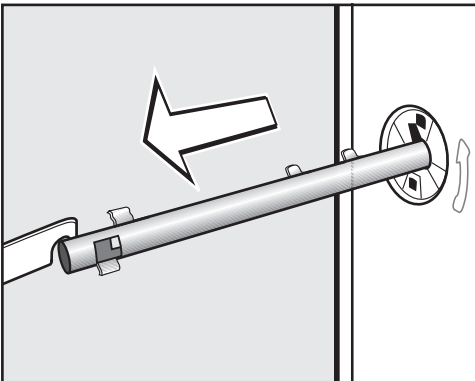

- withdraw the transit bar.

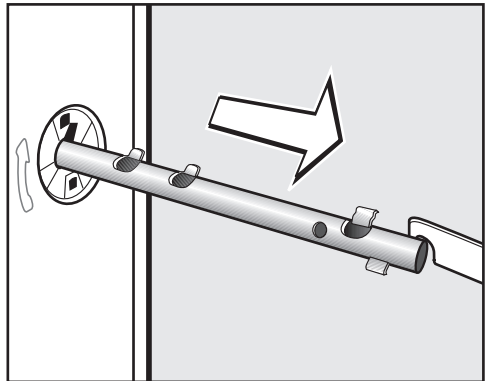

- withdraw the transit bar.

## Installation and connection

 To avoid the risk of injury, the holes for the transit bars must be covered after the transit bars have been removed.

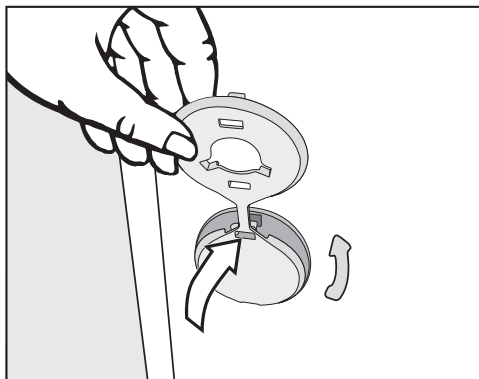

- Fit the covers onto the two holes.

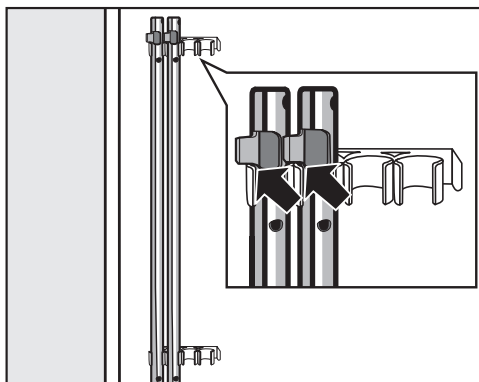

- Secure the transit bars to the back of the washing machine. Make sure the top catch is located above the holder.

 The washing machine must not be moved without the transit bars in place. Store them as shown or keep them in a safe place for future use. They must be refitted if the machine is to be moved again (e.g. when moving house).

### Refitting the transit bars

Refitting is carried out by reversing the procedure.



## Levelling the machine

The washing machine must stand perfectly level on all four feet to ensure safe and proper operation.

Incorrect installation may increase electricity and water consumption and may cause the machine to move about.

## Screwing out and adjusting the feet

The four adjustable screw feet are used to level the machine. All four feet are screwed in when the machine is delivered.

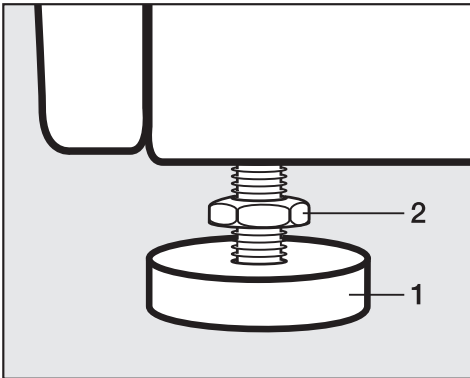

- Using the spanner supplied, turn counter nut **2** in a clockwise direction. Then turn counter nut **2** together with foot **1** to unscrew.

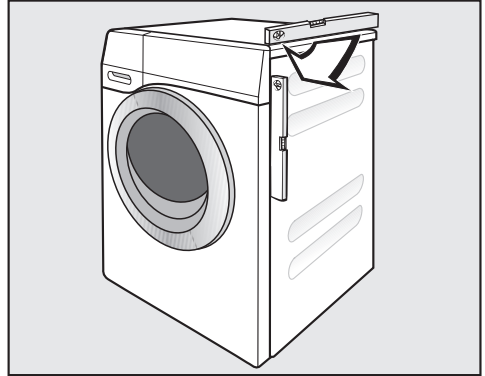

- Use a spirit level to check that the washing machine is standing level.
- Hold foot **1** securely with a pipe wrench. Turn counter nut **2** again using the spanner supplied until it sits firmly up against the housing.

 All four counter nuts must be firmly up against the housing. Please also check this for the feet which did not need adjustment. Otherwise there is a danger of the machine moving about.

# Installation and connection

## Building under a continuous worktop / in a kitchen run

 The washing machine lid cannot be removed.

This washing machine (with lid intact) can be pushed under a worktop if there is space to do so.

## Washer and dryer stack

A Miele tumble dryer can be stacked with the washing machine. The appropriate "WTV" stacking kit\* to match your tumble dryer is required.

All parts marked \* are available from Miele.

### Please note the following:

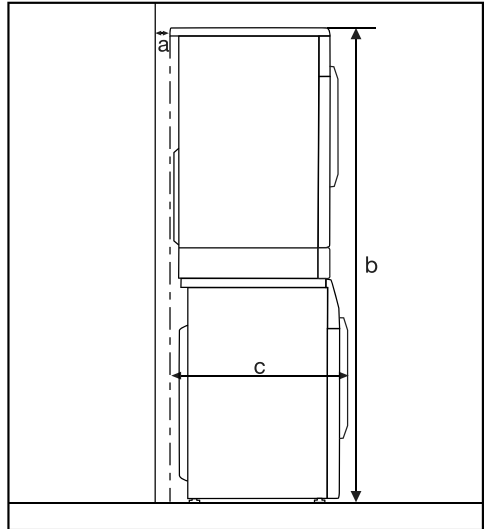

- a** = at least 2 cm
- b** = WTV without drawer: 172 cm  
WTV with drawer: 181 cm
- c** = 68 cm

## The Miele water protection system

The Miele water protection system protects all parts of the washing machine and surrounds from water damage.

The system consists of three main components:

- the inlet hose
- the electronic unit and drainage and overflow protection
- the drain hose

## The Waterproof system (WPS)

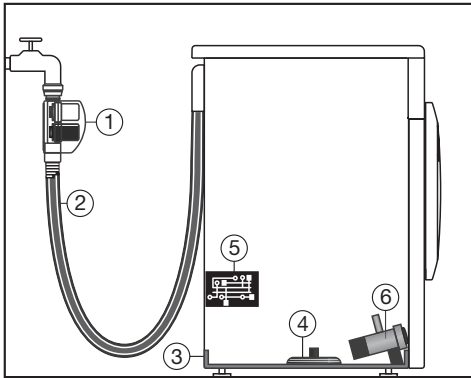

- ① Two solenoid valves
- ② Double-skinned inlet hose
- ③ Sump
- ④ Float switch
- ⑤ Electronic unit
- ⑥ Drain pump

## The inlet hoses

- The casing on the inlet hoses contains two solenoid valves ①, which cut off the water intake directly at the tap. These valves provide two-fold protection. In the event that one of the valves is faulty, the other valve will cut off the water intake. Blocking the water intake at the tap means that the inlet hoses are only under pressure whilst water is being taken into the machine. For the remainder of the time, pressure on the inlet hoses is negligible.

- Protection against the solenoid valves bursting. The solenoid valves are pressure tested to between 7000 kPa and 10000 kPa against bursting.
- The double-skinned inlet hoses ② have a pressure-resistant inner hose and a protective sleeve. Any leaking water is fed into the sump ③ through this protective sleeve. A float switch ④ closes the solenoid valves, preventing any more water flowing into the machine and water in the suds container is pumped away.

# Installation and connection

---

## The electronic unit ⑤ and drainage and overflow protection

- Drainage protection  
Any leaking water is collected in the sump ③ in the base of the machine. A float switch ④ closes the solenoid valves ①, preventing any more water from flowing into the machine and water in the suds container is pumped away.
- Overflow protection  
If the water level exceeds a certain level, the drain pump ⑥ switches in and pumps the excess water away in a controlled manner. Should the water level rise repeatedly in an uncontrolled way, the drain pump ⑥ will switch on continuously, the washing machine will indicate that there is a fault and a tone will sound.

## Drain hose

The drain hose is protected by a ventilation system which prevents the washing machine from being emptied completely.

### Connection to the water supply

#### IMPORTANT Australia and New Zealand

This appliance must be installed according to AS/NZS 3500.1. Backflow prevention is already integrated in the appliance.

 The safety valves contain electrical components. They must not be connected in areas where there is the risk of water or other liquids reaching them, e.g. bathrooms.



The safety valves must not get wet.

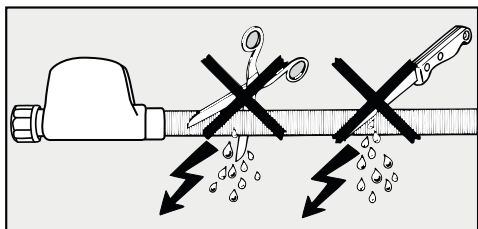

The protective sleeve of the hose must not be damaged or kinked.

The washing machine should be connected to a mains water supply in accordance with current local and national safety regulations.

The machine is designed to operate with a flow pressure of between 100 and 1000 kPa. If it is higher than 1000 kPa, it is essential to fit a reducer valve.

Connection to the water supply should incorporate taps with a  $\frac{3}{4}$ " threaded union. The taps should be fitted by a qualified plumber.

 The connection points are subject to mains water pressure. Turn on the taps slowly and check for leaks. Correct the position of the washer and the union if appropriate.

#### Maintenance and care

Only use a **Miele Waterproof system** hose should you need a replacement.

The union nut on the casing at the end of the water inlet hose contains a dirt filter which protects the solenoid valves. This dirt filter must not be removed.

# Installation and connection

This washing machine can be operated with cold mains water and/or hot water.

## Markings of water intake hoses

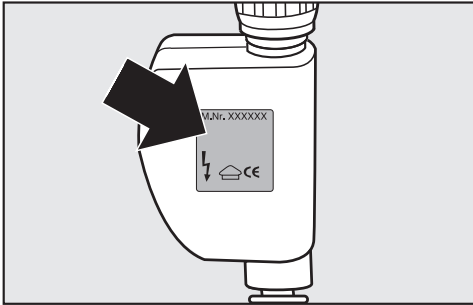

Cold water (tap water) = Silver label

Hot water = Red label



**!** For technical reasons, the washing machine **must** always be connected to cold mains water.

## Cold water (tap water)

The washing machine is programmed to cold water operation at the factory.

The other water intake hose can be fixed at the back of the appliance.

## Hot water

- If you wish to use a hot water connection with the washing machine, it must be reprogrammed as described in "Settings - Water intake".
- The temperature of hot water at the mains water tap must not exceed 60°C. The preferred temperature is 55°C. Consult a plumber if the temperature at the tap exceeds 60°C.
- Before connecting to the mains water tap, check that the outflow of cold water does not exceed 5 litres. Each additional litre of cold water reduces the energy efficiency.
- If the hot water tap is turned off for some time, the washing machine will automatically switch to the cold water connection. This safety measure is not intended for the permanent operation of the appliance. The washing machine continues to wash using hot water operation, but washing results are worsened.
- If the programmed temperature when *Hot water*  +  is selected is too low, the washing machine automatically switches to cold water operation. In a programme without Extra options and without a part load, two rinses with an increased water level are carried out to achieve a good rinsing result.

## Drainage

The machine drains via a drain pump with a delivery head of 1 metre. The drain hose must not be kinked as this restricts drainage. The swivel elbow at the end of the hose can be turned in either direction, or can be detached if required, with a sharp twist and pull. If required, the drain hose can be extended to a length of 5 m. The necessary parts can be purchased from Miele.

For a delivery head of more than 1 m (up to a max. of 1.8 m) a replacement drain pump will need to be fitted. Please contact Miele for advice. If necessary, the drain hose can be extended to a length of 2.5 m. The necessary parts can be purchased from Miele.

### Drain hose connection:

#### 1. Direct into a sink or basin:

Please note:

- Hook the hose over the edge and secure.
- Make sure that the water can drain away freely without hindrance. Otherwise there is a risk of water overflowing or of some of the drained water being sucked back into the machine.

2. Connected securely to a plastic drain pipe with a rubber nipple. There is no need to use a siphon.

3. Connected securely to a floor gully.

4. Connected securely to a standpipe.

Please note:

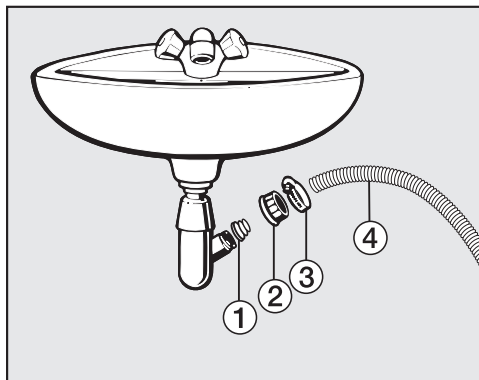

① Adapter

② Nut

③ Hose clip

④ End of the hose

■ Fit the adapter ① to the sink drain outlet using the nut ②.

■ Attach the end of the hose ④ to the adapter ①.

■ Use a screwdriver to tighten the hose clip ③ up close to the nut.

# Installation and connection

---

## Electrical connection

The washing machine is supplied with a mains cable with moulded plug for connection to a 230V mains supply. The voltage, rated load and plug rating are given on the data plate. Please ensure these match the household mains supply.

**WARNING: THIS APPLIANCE MUST BE EARTHED**

 The accessibility of the plug must always be ensured in order to separate the washing machine from the mains. Do not connect the appliance to an extension lead or multi-socket adapter as they do not guarantee the required safety of the appliance (e.g. danger of overheating).

All electrical work should be carried out only by a suitably qualified and competent person, in strict accordance with national and local safety regulations. For extra safety, it is advisable to install a residual current device (RCD), with a trip current of 30 mA. Ensure power is not supplied to the appliance until after installation work has been carried out. Connection should be made via a suitable switched socket.

If the connection cable is damaged, it must be replaced with a Miele cable of the same type by a Miele approved service technician only.



## Consumption data

### Consumption data for the nominated energy labelling programme according to AS/NZS 2040.1 & AS/NZS 2040.2

	Load	Consumption data		
		Energy in kWh	Water in litres	Duration Normal Cold Water
Cottons	8.0 kg	0.65	67	3 h 10 min

#### Notes for test institutes:

Detergent **must** be dispensed via the detergent dispenser drawer.

Consumption data can vary from the nominal values given depending on water pressure, water hardness, water inlet temperature, room temperature, type and volume of load, fluctuations in the electricity supply and any Extra options selected.

# Consumption data

		Load	Consumption data		
			Energy in kWh	Water in litres	Duration
Cottons	90°C	8,0 kg	2.30	58	2 h 34 min
	60°C	8,0 kg	1.35	58	2 h 04 min
	⊏60°C	8,0 kg	1.10	48	3 h 12 min
	40°C	8,0 kg	0.98	72	2 h 40 min
Minimum iron	40°C	4,0 kg	0.60	52	2 h 01 min
Woolens 	30°C	2,0 kg	0.23	35	38 min
Delicates	30°C	3,0 kg	0.40	40	1 h 09 min
Automatic plus	40°C	6,0 kg	0.77	55	2 h 00 min
Express 20 <sup>1)</sup>	40°C	3,5 kg	0.34	30	20 min
Shirts <sup>2)</sup>	60°C	2,0 kg	0.40	40	1 h 11 min

1) Short Extra option activated

2) Pre-ironing Extra option deactivated

Consumption data can vary from the nominal values given depending on water pressure, water hardness, water inlet temperature, room temperature, type and volume of load, fluctuations in the electricity supply and any options selected.

For labelling parameters conforming to AS/NZS 2040.1 & AS/NZS 2040.2, please refer to the previous page of this booklet.

The consumption data shown in the EcoFeedback display can vary from the consumption data quoted here. The variations arise from component tolerances and on-site conditions e.g. fluctuations in the pressure of the water supply, mains voltage and fluctuations in the mains voltage.

## Technical data

Height	850 mm
Width	596 mm
Depth	636 mm
Depth with door open	1054 mm
Height for building under	850 mm
Width for building under	600 mm
Weight	Approx. 100 kg
Capacity	8 kg dry laundry
Voltage	See data plate
Rated load	See data plate
Fuse rating	See data plate
Consumption data	See "Consumption data"
Water flow pressure minimum	100 kPa
Water flow pressure maximum	1000 kPa
Inlet hose length	1.60 m
Drain hose length	1.50 m
Connection cable length	2.00 m
Drain pump head max.	1.00 m
Drain pump length max.	5.00 m
LEDs	Class 1
Test certificates awarded	See data plate
Power consumption when switched off	0.1 W
Power consumption when not switched off	3.0 W

# Settings

You can use the settings to alter the machine's electronics to suit changing requirements.

Settings can be altered at any time.

## Calling up settings

Before you begin, ensure the following:

- The washing machine is switched on.
- The standard display is showing.

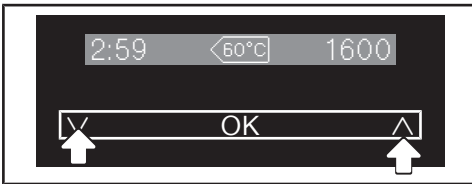

- Touch the  $\nabla$  and  $\blacktriangle$  sensors at the same time.



You are now in the Settings menu.

## Selecting settings

- Touch the  $\nabla$  or  $\blacktriangle$  sensor until the setting you want appears in the display.
- The  $\nabla$  sensor scrolls down the list.
- The  $\blacktriangle$  sensor scrolls up the list.
- Touch the *OK* sensor to select the setting displayed.

## Changing a setting

- Touching the  $\nabla$  sensor will call up the different options for the setting.

The option which is selected will have a tick  $\checkmark$  next to it.

- When the option you want appears in the display, touch the *OK* sensor to activate it.

## Exiting a setting

- Touch the  $\nabla$  or  $\blacktriangle$  sensor repeatedly until *Back*  $\leftarrow$  appears in the display.
- Touch the *OK* sensor.

## Language

The display can be set to appear in one of several different languages.

The flag  after the word *Language* (Sprache in German) acts as a guide in case a language which is not understood has been set.

The language selected is saved to memory.

## Detergent/Amount

For specifying the type of detergent present in the automatic detergent dispensing containers.

See "TwinDos" for more information.

## Degree of soiling

You can select the default setting for the degree of soiling or switch the degree of soiling query on or off.

### Options

- Default setting  
You can choose between the Light, Normal or Heavy degree of soiling settings.  
Factory default setting: Normal
- Query  
You can switch the degree of soiling query on or off.  
Factory default setting: Off

## Buzzer volume

You can select one of seven different settings for the buzzer volume.

The settings are represented by a bar chart. At the lowest setting, the buzzer is switched off.

## Keypad tone

Each touch of a sensor or press of a button is confirmed with an audible tone.

Factory default setting: the keypad tone is switched off.

## Total consumption

In this setting you can check the energy and water consumption values.

### Options

- Display  
Shows the sum of the energy and the sum of the water used by the previous programmes.
- Reset function  
The energy consumption and water consumption totals are reset to zero.

# Settings

---

## PIN Code

The PIN code prevents the washing machine being used without your knowledge.

### Options

- Activate  
The code is 125 and can be activated.  
When the code has been activated, you have to enter the code after switching the washing machine on. Otherwise the washing machine cannot be operated.
- Deactivate  
For using the washing machine without entering the code. This only appears if the code has been activated previously.
- Change  
You can enter a code of your own.

Important! Make a note of your new code. If you forget the code, the washing machine will need to be unlocked by a Miele service technician.

## Temperature unit

The temperature can be displayed as degrees Celsius (°C) or Fahrenheit (°F).

Factory default setting: Celsius (°C).

## Display brightness

There are seven different display brightness settings.

This will change as soon as a different setting is chosen.

## Dark display

To save energy, the display goes out and the indicator light for the *Start/Stop* button will start flashing slowly.

### Options

- On  
The display will go out after 10 minutes.
- On (not in current programme)  
The display will remain on while the programme is running but will go out 10 minutes after the end of the programme.
- Off  
The display will remain on.

Factory default setting: the On (not in current programme) option is selected.

## Appliance switch-off status

The washing machine will switch off automatically after the end of the programme / Anti-crease phase or after being switched on if no further selection is made.

### Options

- 15 minutes (Factory default setting)  
The washing machine will switch itself off after 15 minutes.
- 20 minutes  
The washing machine will switch itself off after 20 minutes.
- 30 minutes  
The washing machine will switch itself off after 30 minutes.

## Memory

The washing machine will save the settings (temperature, spin speed and some of the options) which have been selected for a programme after the programme has started.

When this programme is chosen again, these saved settings will appear in the display.

Factory default setting: the Memory function is switched off.

## Water intake

You can choose between cold water and hot water intake.

### Options

- Cold water (default)  
The washing machine will be operated with cold mains only.
- Hot water (|||)

To save energy, hot water will be used during the main wash if a temperature of 30°C or higher is selected.

To be more energy efficient, you can heat up your water with cheaper, energy saving options, e.g. gas, solar power, oil. The temperature has to be below 60°C.

- Hot water (|||) +   
Hot water is used in the main wash and during rinses. Rinsing with hot water can reduce water consumption by approx. 10%.

 For technical reasons, the washing machine **must** always be connected to cold mains water.

# Settings

---

## Pre-wash Cottons

If you require a longer pre-wash, you can extend the Cottons programme's standard pre-wash time of 25 minutes.

### Options

- No increase (Factory default setting)  
25-minute pre-wash
- +6 min.  
31-minute pre-wash
- +9 min.  
34-minute pre-wash
- +12 min.  
37-minute pre-wash

## Gentle action

Activating gentle action reduces the drum action and is suitable for washing lightly soiled items more gently.

Gentle action can be activated for the *Cottons* and the *Minimum iron* programmes.

Factory default setting: Gentle action is switched off.

## Reduce temp.

The boiling point for water is lower at high altitudes. In order to avoid water boiling, Miele recommends activating the temperature reduction setting at altitudes of more than 2000 m above sea level. The maximum temperature is reduced to 80°C even when a higher temperature is selected.

Factory default setting: the temperature reduction setting is switched off.

## Water plus

You can increase the amount of water delivered in the wash programmes.

### Options

- Water +  
The water level is increased in the wash and rinse stages.
- Extra rinse  
An extra rinse is carried out.
- Water + and Extra rinse  
The water level is increased in the wash and rinse stages and an extra rinse is carried out.



## Water plus level

There are four different water levels which can be selected with Water plus.

### Level:

- Normal (Factory default setting)
- Plus ∆
- Plus ∆∆
- Plus ∆∆∆

## Maximum rinse level

The water level in the rinse cycle can be permanently set to the highest value.

This function is useful for allergy sufferers as it achieves an excellent rinse result. Water consumption will increase.

Factory default setting: the maximum rinse level setting is switched off.

## Suds cooling

When this is activated, additional water flows into the drum at the end of the main wash to cool the suds down. Hot suds can damage plastic drainage pipes.

Suds cooling takes place when a Cottons programme with a temperature of 70°C or higher is selected.

Suds cooling should be activated:

- to prevent the danger of scalding if the drain hose is hooked over the edge of a sink or basin.
- where the drainage pipes do not comply with DIN 1986.

Factory default setting: Suds cooling is switched off.

## Anti-crease

The Anti-crease function helps prevent creasing if laundry is not going to be removed immediately after the end of the programme.

The drum continues to turn at intervals for up to 30 minutes at the end of the programme. The door can be opened at any time.

Factory default setting: Anti-crease is switched off.

## Optional accessories

---

Detergent, fabric care, additives and machine care products are available for this washing machine. All the products have been designed for Miele washing machines.

These and many other useful products can be ordered via the internet at [www.miele-shop.com](http://www.miele-shop.com) (depending on country) or from Miele (see end of this booklet for contact details).



### Detergent

#### UltraPhase 1 and UltraPhase 2

- Universal liquid detergent and detergent enhancer dispensed as two components
- Suitable for white and coloured laundry
- No need to refill as the components for the TwinDos system are supplied in single use cartridges

#### UltraWhite

- Powder detergent
- Suitable for white and light coloured laundry as well as heavily soiled cotton items
- Effective stain removal even at low temperatures

#### UltraColor

- Liquid detergent for coloured items
- Suitable for coloured and dark/black items
- Protects bright colours from fading
- Effective stain removal even at low temperatures
- Also available as a powder detergent.

#### Sensitive Skin powder

- High quality detergent formulated for people with sensitive skin
- Contains no dyes and preservatives
- Most suitable for white or light coloured textiles

### Specialist detergents

Specialist detergents are available as capsules  in convenient single dose amounts or in a handy bottle.

#### Sportswear

- Liquid detergent for sportswear and fleece garments
- Neutralises unpleasant odours
- Retains the shape of the textiles

## Down Items

- Liquid detergent suitable for pillows, sleeping bags and down filled items
- Retains the elasticity of down and feather filled items
- Retains the breathability of down filled items
- Prevents down filling clumping together

## WoolCare

- Liquid detergent for woollens and delicates
- Includes a special wheat protein conditioning formula
- Helps prevent pilling
- Gentle on colours
- Cleans at temperatures as low as 20°C, helps retain the shape of delicate items and protect colours

## SilkCare

- Liquid detergent for silks
- Contains a special silk protein conditioning formula
- Gentle on colours
- Only available as capsules 

## Fabric care

### Fabric Softener

- Fresh, natural fragrance
- Makes laundry soft to handle

## Additives

### Booster

- For removing stains
- Suitable for white and coloured laundry
- Available as capsules  in convenient single dose amounts

## Machine care products

### Dishwasher and washing machine cleaner

- For cleaning the washing machine thoroughly and effectively
- Removes grease, bacteria and unpleasant odours

### Descaler for washing machines

- Removes heavy limescale deposits
- Mild and gentle with natural citric acid







**Miele Australia Pty. Ltd.**

ACN 005 635 398  
ABN 96 005 635 398

**Miele Experience Centre and  
Head Office Melbourne:**

1 Gilbert Park Drive  
Knoxfield, VIC 3180

**Miele Experience Centre South Melbourne:**

206-210 Coventry Street  
South Melbourne, VIC 3205

**Miele Experience Centre and Office Sydney:**

3 Skyline Place  
Frenchs Forest, NSW 2086

**Miele Experience Centre and Office Brisbane:**

39 Harvey Street North  
Eagle Farm, QLD 4009

**Miele Experience Centre Gold Coast:**

131 Ferry Road  
Southport, QLD 4215

**Miele Experience Centre and Office Adelaide:**

83-85 Sir Donald Bradman Drive  
Hilton, SA 5033

**Miele Experience Centre and Office Perth:**

205-207 Stirling Highway  
Claremont, WA 6010



[www.miele.com.au](http://www.miele.com.au)



**Miele New Zealand Limited**

IRD 98 463 631

**Head Office:**

Level 2, 10 College Hill  
Freemans Bay, Auckland 1011

**Miele Experience Centre  
Auckland:**

8 College Hill  
Freemans Bay, Auckland 1011  
Telephone:  
0800 464 353 (0800 4 MIELE)  
[www.miele.co.nz](http://www.miele.co.nz)

**Miele Global Headquarters**

**Germany**

**Miele & Cie. KG**

Carl-Miele-Straße 29  
33332 Gütersloh  
Federal Republic of Germany

WKH 130 WPS



en-AU, NZ

M.-Nr. 10 369 010 / 00